



SERIE **623**



Signalsteckverbinder M23
Signal Connectors M23

23

intercontec
infinite connections



Spitzentechnologie aus Deutschland High-tech made in Germany

Unsere Firmenphilosophie basiert auf dem Grundsatz, überlegene Signal-, Feldbus- und Leistungssteckverbinder mit ihren unendlichen Einsatzmöglichkeiten zu entwickeln und zu fertigen.

Mit Know-How und Marktcompetenz stellen wir Standards in Frage und suchen mit dem richtigen Gespür für die Steckverbindertechnologie von Morgen leidenschaftlich marktorientierte Lösungen.

Dabei schaffen wir Steckverbinder mit präzise durchdachtem Konstruktionsprinzip und einfachster, sicherer Verarbeitbarkeit in der Konfektionierung.

Auf Kundenbedürfnisse einzugehen, optimale Applikationen zu erarbeiten und kompetent anwendungsbezogene Gesamtlösungen schnell zur Marktreife zu bringen, sind die entscheidenden Stärken der Intercontec Firmengruppe.

Die Komponentenproduktion, Endmontage und die Konfektionierung zu fertigen Kabel-Stecker-Baugruppen erfolgt ausschliesslich durch die Intercontec Firmengruppe sowie bei unseren zertifizierten Partnern in Deutschland.

It is our corporate mission to develop superior signal, fieldbus and power connectors for a wide range of applications.

With know-how and market expertise we challenge existing standards. We take a visionary approach to determine the connector technology of the future to provide our customers with innovative and market-oriented solutions.

Our connectors follow highly sophisticated engineering principles safeguarding an extremely easy and efficient assembly process.

By elaborating highly user-friendly optimum system solutions which are brought to the market in a very short time we quickly respond to our customers' needs. This is the key strength of the Intercontec Group.

Production of parts, final assembly and transformation into cable-plug-assemblies is done exclusively by the Intercontec Group as well as our certified partners in Germany.

Kombination Leistungssteckverbinder Serie 923 mit Signalsteckverbinder Serie 623

Application Set-Up of Power Connectors Series 923
and Signal Connectors Series 623

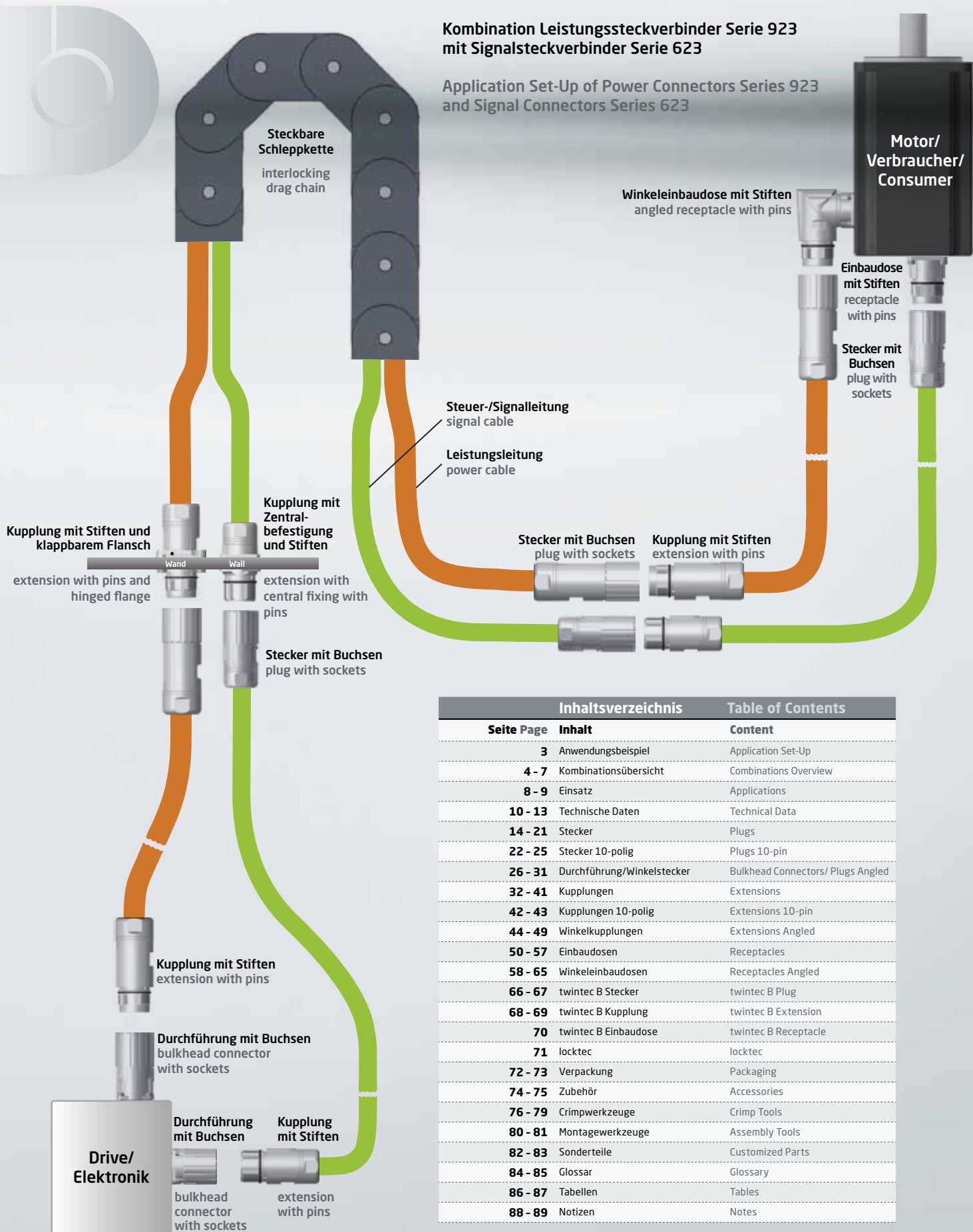

Inhaltsverzeichnis		Table of Contents	
Seite Page	Inhalt	Content	
3	Anwendungsbeispiel	Application Set-Up	
4 - 7	Kombinationsübersicht	Combinations Overview	
8 - 9	Einsatz	Applications	
10 - 13	Technische Daten	Technical Data	
14 - 21	Stecker	Plugs	
22 - 25	Stecker 10-polig	Plugs 10-pin	
26 - 31	Durchführung/Winkelstecker	Bulkhead Connectors/ Plugs Angled	
32 - 41	Kupplungen	Extensions	
42 - 43	Kupplungen 10-polig	Extensions 10-pin	
44 - 49	Winkelkupplungen	Extensions Angled	
50 - 57	Einbaudosen	Receptacles	
58 - 65	Winkeleinbaudosen	Receptacles Angled	
66 - 67	twintec B Stecker	twintec B Plug	
68 - 69	twintec B Kupplung	twintec B Extension	
70	twintec B Einbaudose	twintec B Receptacle	
71	locktec	locktec	
72 - 73	Verpackung	Packaging	
74 - 75	Zubehör	Accessories	
76 - 79	Crimpwerkzeuge	Crimp Tools	
80 - 81	Montagewerkzeuge	Assembly Tools	
82 - 83	Sonderteile	Customized Parts	
84 - 85	Glossar	Glossary	
86 - 87	Tabellen	Tables	
88 - 89	Notizen	Notes	

Stecker S. 12 - 13
Plugs p. 12 - 13

Durchführungen S. 26
Bulkhead Connectors p. 26

Winkelstecker S. 26
Plugs Angled p. 26

Kupplungen S. 32 - 33
Extensions p. 32 - 31



Isolierkörper Insulation Inserts

6-polig (6 x Ø 2 mm)
6-pin (6 x Ø 2 mm)

7-polig (7 x Ø 2 mm)
7-pin (7 x Ø 2 mm)

9-polig (8 x Ø 1 mm + 1 x Ø 2 mm)
9-pin (8 x Ø 1 mm + 1 x Ø 2 mm)

9-polig (9 x Ø 1 mm)
9-pin (9 x Ø 1 mm)



gedrehte Kontaktstifte und Kontaktbuchsen
Crimp- und Lötausführung

turned contact pins and sockets with crimp
and solder connection

gedrehte Kontaktstifte und Kontaktbuchsen
Crimp- oder Lötausführung

turned contact pins and sockets with crimp
or solder connection

Kupplungen mit Zentralbefestigung S. 34 - 36
Extensions with central mount p. 34 - 36

Winkelkupplung S. 44
Extensions Angled p. 44



12-polig (12 x Ø 1 mm)
12-pin (12 x Ø 1 mm)

17-polig (17 x Ø 1 mm)
17-pin (17 x Ø 1 mm)

19-polig (16 x Ø 1 mm + 3 x Ø 1,5 mm)
19-pin (16 x Ø 1 mm + 3 x Ø 1,5 mm)

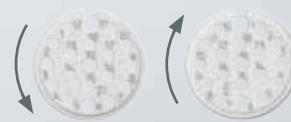

Bandkontaktstifte und -buchsen in Crimpausführung
gedrehte Kontakte in Crimp- und Löt-ausführung

bandoleer contact pins and sockets with crimp connection
turned contacts with crimp or solder connection

Bandkontaktstifte und -buchsen Ø 1 mm in Crimpausführung
gedrehte Kontakte Ø 1 mm und Ø 1,5 mm in Crimp- und Löt-ausführung

bandoleer contact pins and sockets Ø 1 mm with crimp connection
turned contacts Ø 1 mm and Ø 1,5 mm with crimp or solder connection

10-polig -pin

Stecker S. 22
Plugs p. 22

Stecker S. 24
Plug p. 24

Kupplungen S. 42
Extensions p. 42

Einbaudosen S. 50-52
Receptacles p. 50-52



Isolierkörper
Insulation inserts

10-polig (10 x Ø 1 mm)
10-pin (10 x Ø 1 mm)



10-polig (10 x Ø 1 mm)
10-pin (10 x Ø 1 mm)



10-polig (10 x Ø 1 mm)
10-pin (10 x Ø 1 mm)



6-polig (6 x Ø 2 mm)
6-pin (6 x Ø 2 mm)



9-polig (8 x Ø 1 mm + 1 x Ø 2 mm)
9-pin (8 x Ø 1 mm + 1 x Ø 2 mm)



7-polig (7 x Ø 2 mm)
7-pin (7 x Ø 2 mm)



9-polig (9 x Ø 1 mm)
9-pin (9 x Ø 1 mm)



Bandkontaktstifte und -buchsen in Crimpausführung
gedrehte Kontakte in Crimp- oder Löttausführung

bandoleer contact pins and sockets with crimp connection
turned contacts with crimp or solder connection

gedrehte Kontaktstifte und Kontaktbuchsen
Crimp- oder Löttausführung

turned contact pins and sockets with crimp or solder connection

gedrehte Kontaktstifte und Kontaktbuchsen
Crimp- oder Löttausführung

turned contact pins and sockets with crimp or solder connection

twintec B

Winkeleinbaudosen S. 58 - 60
Receptacles Angled p. 58 - 60



Stecker S. 66
Plug p. 66

Kupplung S. 68
Extension p. 68

Einbaudose S. 70
Receptacle p. 70



12-polig (12 x Ø 1 mm)
12-pin (12 x Ø 1 mm)

19-polig (16 x Ø 1 mm + 3 x Ø 1,5 mm)
19-pin (16 x Ø 1 mm + 3 x Ø 1,5 mm)

19-polig (15 x Ø 1 mm + 4 x Ø 1 mm)

19-polig (15 x Ø 1 mm + 4 x Ø 1 mm)

19-polig (15 x Ø 1 mm + 4 x Ø 1 mm)



19-pin (15 x Ø 1 mm + 4 x Ø 1 mm)

19-pin (15 x Ø 1 mm + 4 x Ø 1 mm)

19-pin (15 x Ø 1 mm + 4 x Ø 1 mm)

17-polig (17 x Ø 1 mm)
17-pin (17 x Ø 1 mm)



Bandkontaktstifte und -buchsen in Crimpausführung; gedrehte Kontakte in Crimp- oder Löttausführung
bandoleer contact pins and sockets with crimp connection; turned contacts with crimp or solder connection

Bandkontaktstifte und -buchsen Ø 1 mm in Crimpausführung; gedrehte Kontakte Ø 1 mm und Ø 1,5 mm in Crimp- oder Löttausführung
bandoleer contact pins and sockets Ø 1 mm with crimp connection; turned contacts Ø 1 mm and Ø 1,5 mm with crimp or solder connection

gedrehte Kontaktstifte und Kontaktbuchsen Crimp- oder Löttausführung

turned contact pins and sockets with crimp or solder connection



Unendlich viele Einsatzmöglichkeiten



Entwicklung Development



Die eigene 3D-Konstruktionsabteilung ist der Schlüssel zu einer erfolgreichen, applikationsnahen Entwicklung von Steckverbindern. Our own 3D engineering department is the key to a successful, application oriented development of connectors.

Modernster Muster- und Prototypenbau State-of-the-art Prototyping



Eigener großer Maschinenpark zur kompletten Fertigung unserer Muster und Prototypen. Intercontec's large machine park for prototype manufacturing.

Automatisierte Steckermontage Automated Connector Assembly



Automatisierte Montagelinien zur prozesssicheren Fertigung unserer Bauteile und Komponenten. Automated production lines ensure reliable processing of our components and subassemblies.

Eigene Kabelkonfektion In-House Cable Assembly



Fertig konfektionierte Baugruppen, maschinell gefertigt, 100% geprüft. Completely assembled components, automated production, 100% tested.



Unlimited Range of Applications



Eigenes Prüflabor
In-House Test Laboratory

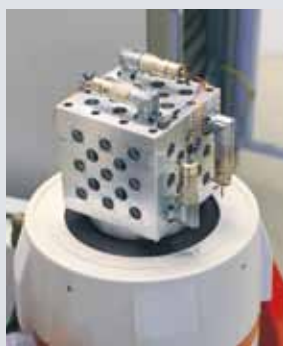

Qualifizierung unserer Produkte für 100% Qualität und Normenkonformität. Qualification of our products to deliver 100% quality and standard conformity.

Bauteilvermessung, Werkstoffprüfung
Component Measuring, Material Testing



Bauteilvermessung und Fertigungskontrolle mit Computertomographen. Component measuring and production control with computer tomography.

Weltweiter Vertrieb
International Distribution



Große Lagerkapazität, organisiertes Ersatzteilmanagement für weltweite Just-In-Time-Lieferung. High warehouse capacity, organized part management with worldwide just-in-time delivery.

Unendliche Verbindungen
Infinite Connections



Für jeden Einsatzzweck die richtige Steckverbindung: modular - zuverlässig - innovativ. The suitable connector for every application: modular - dependable - innovative.



DIN EN ISO 9001:2000

Qualität

Das bewährte Qualitätssicherungssystem nach DIN EN ISO 9001:2000 gibt Anwendern weltweit die Sicherheit normenkonformer Qualität.

Intercontec zertifiziert laufend seine Steckverbinder nach UL / CSA (File No. E 247738) und VDE.

Die Qualifizierungen zur Zulassung gemäß diesen nationalen und internationalen Standards erfolgen im eigenen Testlabor in Niederwinkling.

Sehr hohe, spezielle Intercontec Anforderungen, welche in vielen Punkten die der nationalen und internationalen Normen übersteigen, werden in eigenen Hausnormen festgelegt, dokumentiert und in Form von Typprüfungen im Intercontec Labor aufwendigen und einsatznahen Prüfungen unterzogen.

Der hohe Automatisierungsgrad bei der Steckermontage stellt zudem durch die automatischen, Serienfertigung begleitenden Kontrollen höchste Prozesssicherheit und nahezu 100 % Qualität (< 100 ppm) sicher.

Unsere 100 % Crimp- und Auszugskraft geprüfte, maschinelle Verarbeitung unserer Kontakte an Crimpautomaten wird regelmäßig durch fertigungsbegleitende, mikroskopische Schliffbildprüfungen und lebensdauerrelevante Steckzyklentests ergänzt.

Fertigungsbegleitende 100 % Kontrolle in Form von IP Schutzart-, Belegungs-, Durchgangs- und Steckprüfungen garantieren zudem die optimale Güte unserer Kabelbaugruppen.

Quality

The quality management system according to DIN EN ISO 9001:2000 provides standard conforming quality for users worldwide.

Intercontec connectors are being continuously certified according to UL / CSA (File No. E 247738) and VDE.

Qualifications for certifications according to these national and international standards are being performed at the in-house test laboratory in Niederwinkling.

Very high, special Intercontec demands, which surpass national and international standards in many regards are set in specific company standards, documented and verified with real life tests in the Intercontec laboratory. The high automation level of the connector assembly with real-time control during production provides highest process liability and optimum quality.

All contacts that are processed with a crimp machine are 100 % extraction force and crimp quality tested. In regular intervals microscopic micro-section tests and mating cycle tests are conducted.

Integrated real-time controls during production in terms of IP protection, pin configuration, continuity and mating tests guarantee optimum performance of our cable assemblies.

DIN 40050 IP 66/67

IP-Schutzart nach DIN 40050

Alle Intercontec - Steckverbinder erfüllen - soweit nicht ausdrücklich anders angegeben - die Schutzart IP 66/67 (gemäß IEC 60529). Steckverbinder müssen gemäß der Bauartvorschrift gegen funktionsbeeinträchtigende Umgebungseinflüsse (Staub, Feuchtigkeit, etc.) geschützt sein. Die Schutzart wird nach Norm mit zwei Kennziffern definiert.

(siehe Tabellenanhang)

IP Protection Rating according to DIN 40050

All Intercontec connectors are IP67 rated (per IEC60529) unless specifically stated otherwise. According to the design specification connectors have to be protected against environmental influences that limit the performance (dust, humidity, cleaning solvents, etc.)

(see tables in the appendix)

DIN EN ISO 60512

Schirmung und Elektromagnetische Verträglichkeit (EMV)

Die Intercontec Schirmung liegt koaxial über 360° am Gehäuse an und stellt so eine optimale elektromagnetische Verträglichkeit sicher. Gemäß den gesetzlichen Bestimmungen über die elektromagnetische Verträglichkeit müssen Geräte so beschaffen sein, dass

1. die Erzeugung elektromagnetischer Störungen soweit begrenzt wird, dass ein bestimmungsgemäßer Betrieb möglich ist.
2. Geräte eine angemessene Festigkeit gegen elektromagnetische Störungen aufweisen, so dass ein bestimmungsgemäßer Betrieb möglich ist.

Strombelastbarkeit

Alle Angaben über die Strombelastbarkeit wurden im Intercontec Labor konform zur DIN EN 60512 ermittelt. Dabei wird ein Strombelastbarkeitsdiagramm (Deratingkurve) erstellt, das zeigt, welcher Strom dauernd und gleichzeitig über alle Kontakte fließen darf.

Hierzu ist die DIN EN 60512 heranzuziehen.

Die Grenztemperatur ergibt sich durch die thermischen Eigenschaften der Kontakt- und Isolierwerkstoffe. Die Summe aus der Umgebungstemperatur und der durch die Strombelastung hervorgerufenen Temperaturerhöhung darf die Grenztemperatur des Steckverbinders nicht überschreiten.

Die Strombelastbarkeit ist kein konstanter Wert, sondern sinkt mit steigender Umgebungstemperatur.

Shielding and Electromagnetic Compatibility (EMC)

The Intercontec shielding rests on the housing coaxially 360° which provides optimum electromagnetic compatibility. According to legal EMC regulations devices must fulfill the following standards:

1. Electromagnetic interference must be limited to the degree that the intended operation is possible.
2. Devices must provide an appropriate resistance against electromagnetic interference to ensure the intended operation is possible.

Current Carrying Capacity

All specifications regarding electric current carrying capacity were determined in the Intercontec laboratory according to DIN EN 60512. In this process a current carrying capacity diagram (derating curve) is created, which shows the maximum continuous current flowing through all contacts simultaneously.

The upper temperature limit is defined by the thermal characteristics of contact and insulation material. The sum of ambient temperature and the temperature rise caused by the operating current must not exceed the temperature limit of the connector.

The current carrying capacity is not a constant value, but decreases with rising ambient temperature.

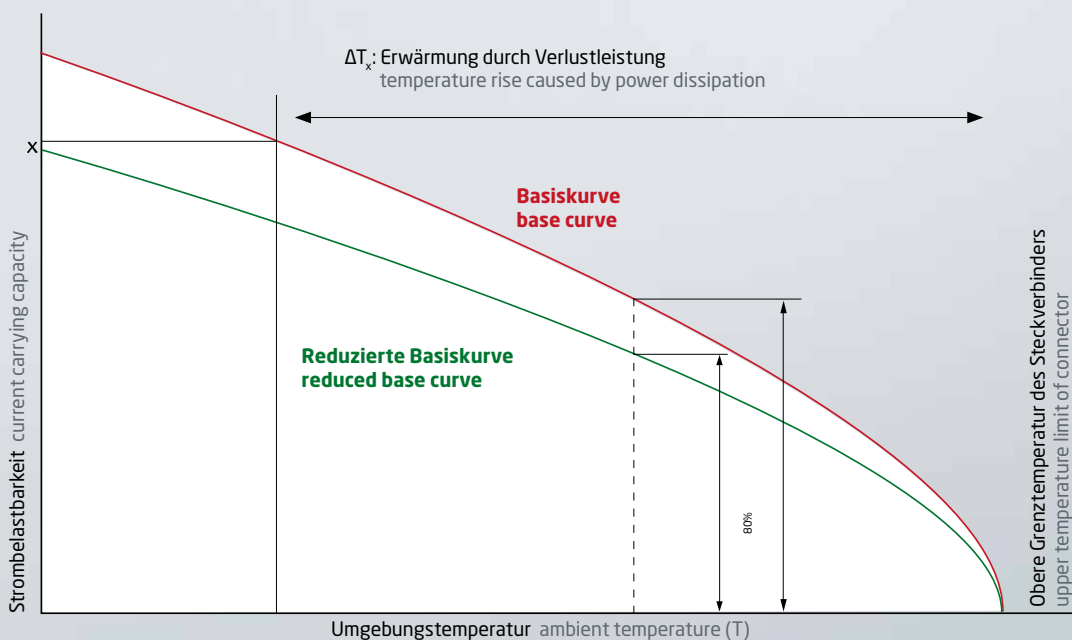

Verwendete Werkstoffe		
Gehäuse	Messing, Zinkdruckguss; vernickelt, chromatiert, kunststoff	Je nach Einsatzgebiet wird für die Metallgehäuse Messing oder Zinkdruckguss eingesetzt. Bei großen Stückzahlen wird in den meisten Fällen Zinkdruckguss verwendet. Bei runden Teilen kommt vorrangig Messing zum Einsatz. Zur Gewichtsreduktion werden Kunststoffummantelungen auf volumenreduzierten Metallgehäusen verwendet.
Überwurfmutter	Messing, Zinkdruckguss; vernickelt	
Isolierkörper	PA/PBT, UL 94/V0	Für Isolierkörper bei Steckverbindern werden vorrangig PBT und hochwertige PA-Varianten eingesetzt, die besonders für hochbeanspruchte technische Spritzgussteile geeignet sind. Der Kunststoff hat sehr gute chemische, elektrische und mechanische Eigenschaften.
Kontakte	Messing vergoldet	Die Eigenschaften der Kontakte werden weitgehend von den eingesetzten Werkstoffen bestimmt. Entscheidende Merkmale sind u.a. <ul style="list-style-type: none"> ▶ Festigkeit bzw. Federeigenschaften ▶ Elektrische Leitfähigkeit ▶ Max. Einsatztemperatur ▶ Verformbarkeit
Dichtungen	FPM/HNBR	Um den industriellen Anforderungen an die Beständigkeit gegen Öl, Fett, Lösungsmittel sowie Säuren, Laugen, Chemikalien und extremen Temperaturbelastungen gerecht zu werden, müssen spezielle Dichtungen verwendet werden. Diese bestehen bei Intercontec aus Fluor-Kautschuk [Viton].
	EPDM	Für besondere Einsatzzwecke im Freien, die Witterungs-, Ozon-, UV- und Temperaturbeständigkeit bis -50° C erfordern, setzen wir Ethylen-Propylen-Dien-Kautschuk (EPDM) ein.
Klemmring	Messing; vernickelt, kunststoff	

Materials		
Housing	brass, zinc diecast; nickel-plated, chromated, plastic coated	Depending on the application the material of the metal housing is either made of brass or zinc diecast. Zinc diecast is used for larger lot sizes and brass primarily for round parts. Special plastic coats on metal housings with reduced volume are designed to reduce connector weight.
Coupling Nut	brass, zinc diecast; nickel-plated	
Insulation Insert	PA/PBT, UL 94/V0	For insulation inserts of connectors PBT and high-quality PA-variants are used that are especially suitable for highly stressed technical diecast parts. This plastic has very good chemical, electrical and mechanical properties.
Contacts	brass gold plated	The contact characteristics depend mainly on the materials. Especially important are: <ul style="list-style-type: none"> ▶ stability and flexibility characteristics ▶ electrical conductivity ▶ max. operating temperature ▶ formability
Seals	FPM/HNBR	Special seals have to be used to cope with industrial requirements for resistance against oil, grease, solvents and acids, bases and chemicals as well as extreme temperatures. At Intercontec the standard material is fluor rubber [Viton].
	EPDM	For special outdoor applications, which require weather, ozone, UV and temperature resistance down to -50° C we use ethylene propylen dien rubber (EPDM).
Clamp Ring	brass; nickel-plated, plastic coated	

**Werte nach VDE 0110/EN 61984,
Abschnitt 6.19.2.2**

Verschmutzungsgrad	3
Überspannungskategorie	III
Maximale Aufstellhöhe	2000 m

Individuelle VDE Zertifizierungen und Zulassungen sind auf Anfrage möglich.

**Values according to VDE 0110/EN 61984,
part 6.19.2.2**

pollution degree	3
over voltage category	III
max. height for operation	2000 m

Individual VDE certifications and accreditations available on request.

Allgemeine technische Daten

Kontaktanschlusarten

Crimpausführung, Lötkelch, einlöt

Temperaturbereich

-20° C bis 130° C

Schutzart

gesteckt IP 66/67

Schirmung

EMV - Gehäuseschirmung

Steckzyklen

min. 500

Kabelklemmbereich

Ø 3,5 - Ø 14,7 mm

Verriegelungsarten

Schraub M23 x 1; Schnellverschluss speedtec

General Technical Data

Contact Terminations

crimp version, solder cup, solder-in

Temperature Range

-20° C to 130° C

Protection Type

IP 66/67 when connected

Shielding

EMC shielded housing

Mating Cycles

min. 500

Clamping Range

Ø 3.5 - Ø 14.7 mm

Locking Types

threaded version M23 x 1; quick lock system speedtec

Elektrische Daten Electrical Data

	Bemessungsstrom bei max. Anschlussquerschnitt rated current at max. connection cross section	Bemessungsspannung (AC/DC) rated voltage (AC/DC)	Bemessungsspannung (L-L) rated insulation voltage	Polzahl number of pins	Kontakt Ø contact Ø	Max. Anschlussquerschnitt max. cross section
	[A]	[V]	[kV]		[mm]	[mm ²]
6	20	32	1,5	6	2	2,5
7	20	32	1,5	7	2	2,5
9 (8+1)	10	160	2,5	9 (8+1)	1/2	1/2,5
9	10	160	2,5	9	1	1
10	9	125	4,0	10	1	1
12	7	160	2,5	12	1	1
17	7	125	2,0	17	1	1
19 (16+3)	7	63	1,5	19 (16+3)	1/1,5	1/1,5
twintec B	7	63	2,0	19 (14+PE +4)	1	1

Isolierkörper und Kontakte



6-polig P 6-pin P (6 x Ø 2 mm)

0° codiert 0° coded

Ansicht steckseitig mating view



7-polig P 7-pin P (7 x Ø 2 mm)

0° codiert 0° coded

Ansicht steckseitig mating view



6-polig E 6-pin E (6 x Ø 2 mm)

0° codiert 0° coded

Ansicht steckseitig mating view

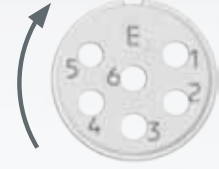

7-polig E 7-pin E (7 x Ø 2 mm)

0° codiert 0° coded

Ansicht steckseitig mating view

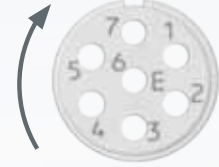

Kontaktbuchse Ø 2 mm Contact Socket Ø 2 mm

Nicht im Lieferumfang enthalten Not part of product contents



Ø 2 mm

geschlitzt, Crimpbereich 0,35 - 2,5 mm²
slotted, crimping range 0.35 - 2.5 mm²

Art.-Nr. Art. No. 60.012.11



Ø 2 mm

geschlitzt, Lötkelch 2,5 mm²
slotted, solder bucket 2.5 mm²

60.014.11



Kontaktstift Ø 2 mm Contact Pin Ø 2 mm

Nicht im Lieferumfang enthalten Not part of product contents



Ø 2 mm

Crimpbereich 0,35 - 2,5 mm²
crimping range 0.35 - 2.5 mm²

Art.-Nr. Art. No. 61.008.11



Ø 2 mm

Lötkelch 2,5 mm²
solder bucket 2.5 mm²

61.011.11

Insulation Inserts and Contacts



8+1-polig P 8+1-pin P (8 x Ø 1 mm + 1 x Ø 2 mm)

uncodiert uncodced

Ansicht steckseitig mating view



8+1-polig E 8+1-pin E (8 x Ø 2 mm + 1 x Ø 1 mm)

uncodiert uncodced

Ansicht steckseitig mating view

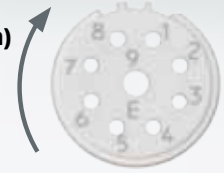

Kontaktbuchse Ø 1 mm Contact Socket Ø 1 mm Nicht im Lieferumfang enthalten Not part of product contents



Ø 1 mm
Drahtfeder, Crimpbereich 0,14 - 1,0 mm²
wire spring, crimping range 0.14 - 1.0 mm²
60.001.11



Ø 1 mm
geschlitzt, Crimpbereich 0,14 - 1,0 mm²
slotted, crimping range 0.14 - 1.0 mm²
60.011.11



Ø 1 mm
Drahtfeder, Lötkehl 1,5 mm²
wire spring, solder bucket 1.5 mm²
60.004.11



Ø 1 mm
geschlitzt, Lötkehl 1,5 mm²
slotted, solder bucket 1.5 mm²
60.013.11



Ø 1 mm
geschlitzt, Crimpbereich 0,03 - 0,34 mm²
slotted, crimping range 0.03 - 0.34 mm²
60.172.11

Art.-Nr. Art. No.



Kontaktbuchse Ø 2 mm Contact Socket Ø 2 mm Nicht im Lieferumfang enthalten Not part of product contents



Ø 2 mm
geschlitzt, Crimpbereich 0,35 - 2,5 mm²
slotted, crimping range 0.35 - 2.5 mm²
60.012.11



Ø 2 mm
geschlitzt, Lötkehl 2,5 mm²
slotted, solder bucket 2.5 mm²
60.014.11

Art.-Nr. Art. No.



Kontaktstift Ø 1 mm Contact Pin Ø 1 mm Nicht im Lieferumfang enthalten Not part of product contents



Ø 1 mm
Crimpbereich 0,14 - 1,0 mm²
crimping range 0.14 - 1.0 mm²
61.004.11



Ø 1 mm
Lötkehl 1,5 mm²
solder bucket 1.5 mm²
61.006.11



Ø 1 mm
Crimpbereich 0,03 - 0,34 mm²
crimping range 0.03 - 0.34 mm²
61.083.11

Art.-Nr. Art. No.



Kontaktstift Ø 2 mm Contact Pin Ø 2 mm Nicht im Lieferumfang enthalten Not part of product contents



Ø 2 mm
Crimpbereich 0,35 - 2,5 mm²
crimping range 0.35 - 2.5 mm²
61.008.11



Ø 2 mm
Lötkehl 2,5 mm²
solder bucket 2.5 mm²
61.011.11

Art.-Nr. Art. No.

Isolierkörper und Kontakte



9-polig P 9-pin P (9 x Ø 1 mm)

uncodiert uncoded

Ansicht steckseitig mating view



9-polig E 9-pin E (9 x Ø 1 mm)

uncodiert uncoded

Ansicht steckseitig mating view



Kontaktbuchse Ø 1 mm Contact Socket Ø 1 mm Nicht im Lieferumfang enthalten Not part of product contents



Ø 1 mm

Drahtfeder, Crimpbereich 0,14 - 1,0 mm²
wire spring, crimping range 0.14 - 1.0 mm²

Art.-Nr. Art. No. **60.001.11**



Ø 1 mm

geschlitzt, Crimpbereich 0,14 - 1,0 mm²
slotted, crimping range 0.14 - 1.0 mm²

60.011.11



Ø 1 mm

Drahtfeder, Lötkehlch 1,5 mm²
wire spring, solder bucket 1.5 mm²

60.004.11



Ø 1 mm

geschlitzt, Lötkehlch 1,5 mm²
slotted, solder bucket 1.5 mm²

60.013.11



Ø 1 mm

geschlitzt, Crimpbereich 0,03 - 0,34 mm²
slotted, crimping range 0.03 - 0.34 mm²

60.172.11



Kontaktstift Ø 1 mm Contact Pin Ø 1 mm Nicht im Lieferumfang enthalten Not part of product contents



Ø 1 mm

Crimpereich 0,14 - 1,0 mm²
crimping range 0.14 - 1.0 mm²

Art.-Nr. Art. No. **61.004.11**



Ø 1 mm

Lötkehlch 1,5 mm²
solder bucket 1.5 mm²

61.006.11



Ø 1 mm

Crimpereich 0,03 - 0,34 mm²
crimping range 0.03 - 0.34 mm²

61.083.11

Insulation Inserts and Contacts



12-polig P 12-pin P (12 x Ø 1 mm)

0° codiert 0° coded

Ansicht steckseitig mating view



12-polig E 12-pin E (12 x Ø 1 mm)

0° codiert 0° coded

Ansicht steckseitig mating view

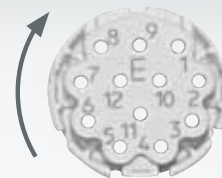

17-polig P 17-pin P (17 x Ø 1 mm)

0° codiert 0° coded

Ansicht steckseitig mating view

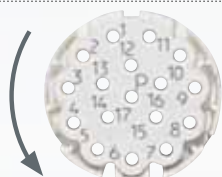

17-polig E 17-pin E (17 x Ø 1 mm)

0° codiert 0° coded

Ansicht steckseitig mating view

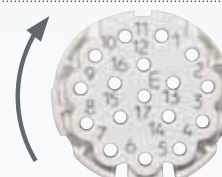

Kontaktbuchse Ø 1 mm Contact Socket Ø 1 mm Nicht im Lieferumfang enthalten Not part of product contents



Ø 1 mm
Drahtfeder, Crimpbereich 0,14 - 1,0 mm²
wire spring, crimping range 0.14 - 1.0 mm²
60.001.11



Ø 1 mm
geschlitzt, Crimpbereich 0,14 - 1,0 mm²
slotted, crimping range 0.14 - 1.0 mm²
60.011.11



Ø 1 mm
Drahtfeder, Lötkelch 1,5 mm²
wire spring, solder bucket 1.5 mm²
60.004.11



Ø 1 mm
geschlitzt, Lötkelch 1,5 mm²
slotted, solder bucket 1.5 mm²
60.013.11



Ø 1 mm
geschlitzt, Crimpbereich 0,03 - 0,34 mm²
slotted, crimping range 0.03 - 0.34 mm²
60.172.11

Art.-Nr. Art. No.



Kontaktstift Ø 1 mm Contact Pin Ø 1 mm Nicht im Lieferumfang enthalten Not part of product contents



Ø 1 mm
Crimpbereich 0,14 - 1,0 mm²
crimping range 0.14 - 1.0 mm²
61.004.11



Ø 1 mm
Lötkelch 1,5 mm²
solder bucket 1.5 mm²
61.006.11



Ø 1 mm
Crimpbereich 0,03 - 0,34 mm²
crimping range 0.03 - 0.34 mm²
61.083.11

Art.-Nr. Art. No.



Bandkontaktbuchse Ø 1 mm Bandoleer Contact Socket Ø 1 mm Nicht im Lieferumfang enthalten Not part of product contents



Ø 1 mm
Crimprgröße 1 (0,03 - 0,08 mm²)
7000 Stück auf Rolle
crimping size 1 (0.03 - 0.08 mm²)
7000 pcs on reel
60.198.80



Ø 1 mm
Crimprgröße 2 (0,08 - 0,20 mm²)
7000 Stück auf Rolle
crimping size 2 (0.08 - 0.20 mm²)
7000 pcs on reel
60.199.80



Ø 1 mm
Crimprgröße 3 (0,20 - 0,52 mm²)
7000 Stück auf Rolle
crimping size 3 (0.20 - 0.52 mm²)
7000 pcs on reel
60.200.80



Ø 1 mm
Crimprgröße 4 (0,75 - 1,0 mm²)
10000 Stück auf Rolle
crimping size 4 (0.75 - 1.0 mm²)
10000 pcs on reel
60.201.80

Art.-Nr. Art. No.



Bandkontaktstift Ø 1 mm Bandoleer Contact Pin Ø 1 mm Nicht im Lieferumfang enthalten Not part of product contents



Ø 1 mm
Crimprgröße 1 (0,03 - 0,08 mm²)
7000 Stück auf Rolle
crimping size 1 (0.03 - 0.08 mm²)
7000 pcs on reel
61.170.80

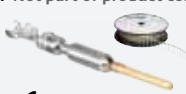

Ø 1 mm
Crimprgröße 2 (0,08 - 0,20 mm²)
7000 Stück auf Rolle
crimping size 2 (0.08 - 0.20 mm²)
7000 pcs on reel
61.171.80



Ø 1 mm
Crimprgröße 3 (0,20 - 0,52 mm²)
7000 Stück auf Rolle
crimping size 3 (0.20 - 0.52 mm²)
7000 pcs on reel
61.172.80



Ø 1 mm
Crimprgröße 4 (0,75 - 1,0 mm²)
10000 Stück auf Rolle
crimping size 4 (0.75 - 1.0 mm²)
10000 pcs on reel
61.173.80

Art.-Nr. Art. No.

Isolierkörper und Kontakte Insulation Inserts and Contacts

558

16+3-polig P 16+3-pin P (16 x Ø 1 mm + 3 x Ø 1,5 mm)

0° codiert 0° coded

Ansicht steckseitig mating view

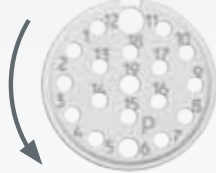

559

16+3-polig E 16+3-pin E (16 x Ø 1 mm + 3 x Ø 1,5 mm)

0° codiert 0° coded

Ansicht steckseitig mating view

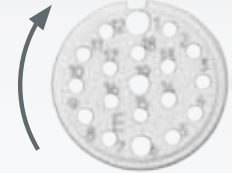

NN 00

Kontaktbuchse Ø 1 mm Contact Socket Ø 1 mm

Nicht im Lieferumfang enthalten Not part of product contents



Ø 1 mm

Drahtfeder, Crimpbereich 0,14 - 1,0 mm²
wire spring, crimping range 0.14 - 1.0 mm²

Art.-Nr. Art. No. 60.001.11



Ø 1 mm

geschlitzt, Crimpbereich 0,14 - 1,0 mm²
slotted, crimping range 0.14 - 1.0 mm²

60.011.11



Ø 1 mm

Drahtfeder, Lötkehl 1,5 mm²
wire spring, solder bucket 1.5 mm²

60.004.11



Ø 1 mm

geschlitzt, Lötkehl 1,5 mm²
slotted, solder bucket 1.5 mm²

60.013.11



Ø 1 mm

geschlitzt, Crimpbereich 0,03 - 0,34 mm²
slotted, crimping range 0.03 - 0.34 mm²

60.172.11

NN 00

Kontaktbuchse Ø 1,5 mm Contact Socket Ø 1,5 mm

Nicht im Lieferumfang enthalten Not part of product contents



Ø 1,5 mm

geschlitzt, Crimpbereich 0,24 - 1,0 mm²
slotted, crimping range 0.24 - 1.0 mm²

Art.-Nr. Art. No. 60.070.11



Ø 1,5 mm

geschlitzt, Lötkehl 1,5 mm²
slotted, solder bucket 1.5 mm²

60.173.11

NN 00

Kontaktstift Ø 1 mm Contact Pin Ø 1 mm

Nicht im Lieferumfang enthalten Not part of product contents



Ø 1 mm

Crimpereich 0,14 - 1,0 mm²
crimping range 0.14 - 1.0 mm²

Art.-Nr. Art. No. 61.004.11



Ø 1 mm

Lötkehl 1,5 mm²
solder bucket 1.5 mm²

61.006.11



Ø 1 mm

Crimpereich 0,03 - 0,34 mm²
crimping range 0.03 - 0.34 mm²

61.083.11



Ø 1,5 mm

Crimpereich 0,24 - 1,0 mm²
crimping range 0.24 - 1.0 mm²

61.072.11



Ø 1,5 mm

Lötkehl 1,5 mm²
solder bucket 1.5 mm²

61.152.11

NN 00

Bandkontaktbuchse Ø 1 mm Bandoleer Contact Socket Ø 1 mm

Nicht im Lieferumfang enthalten Not part of product contents



Ø 1 mm

Crimpgröße 1 (0,03 - 0,08 mm²)
7000 Stück auf Rolle
crimping size 1 (0.03 - 0.08 mm²)
7000 pcs on reel

Art.-Nr. Art. No. 60.198.80



Ø 1 mm

Crimpgröße 2 (0,08 - 0,20 mm²)
7000 Stück auf Rolle
crimping size 2 (0.08 - 0.20 mm²)
7000 pcs on reel

60.199.80



Ø 1 mm

Crimpgröße 3 (0,20 - 0,52 mm²)
7000 Stück auf Rolle
crimping size 3 (0.20 - 0.52 mm²)
7000 pcs on reel

60.200.80



Ø 1 mm

Crimpgröße 4 (0,75 - 1,0 mm²)
10000 Stück auf Rolle
crimping size 4 (0.75 - 1.0 mm²)
10000 pcs on reel

60.201.80

NN 00

Bandkontaktstift Ø 1 mm Bandoleer Contact Pin Ø 1 mm

Nicht im Lieferumfang enthalten Not part of product contents



Ø 1 mm

Crimpgröße 1 (0,03 - 0,08 mm²)
7000 Stück auf Rolle
crimping size 1 (0.03 - 0.08 mm²)
7000 pcs on reel

Art.-Nr. Art. No. 61.170.80



Ø 1 mm

Crimpgröße 2 (0,08 - 0,20 mm²)
7000 Stück auf Rolle
crimping size 2 (0.08 - 0.20 mm²)
7000 pcs on reel

61.171.80



Ø 1 mm

Crimpgröße 3 (0,20 - 0,52 mm²)
7000 Stück auf Rolle
crimping size 3 (0.20 - 0.52 mm²)
7000 pcs on reel

61.172.80



Ø 1 mm

Crimpgröße 4 (0,75 - 1,0 mm²)
10000 Stück auf Rolle
crimping size 4 (0.75 - 1.0 mm²)
10000 pcs on reel

61.173.80

Kabelklemmungen Cable Clamps



Kronenklemmung Crown Clamp

Kabelklemmbereich 3,5 - 5,6 mm cable clamping range 3.5 - 5.6 mm

Integrierte Dichtung, Verdrehsicherung und koaxiale Kronen-Schirmanbindung
Keine Schirmkürzung erforderlich

Integrated sealing, anti-twist protection and coaxial crown shield connection
No shield trimming required

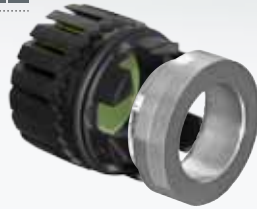

Kabelklemmbereich 4,5 - 8,5 mm cable clamping range 4.5 - 8.5 mm



Kabelklemmbereich 6,0 - 10,0 mm cable clamping range 6.0 - 10.0 mm



Kabelklemmbereich 9,0 - 13,2 mm cable clamping range 9.0 - 13.2 mm



Kabelklemmbereich 9,0 - 14,7 mm cable clamping range 9.0 - 14.7 mm



Lamellenklemmung Lamella Clamp

Kabelklemmbereich 3,5 - 5,6 mm cable clamping range 3.5 - 5.6 mm

Integrierte Dichtung, Verdrehsicherung und koaxiale Schirmanbindung.
Integrierte sealing, anti-twist protection and coaxial shield connection.



Kabelklemmbereich 4,5 - 8,5 mm cable clamping range 4.5 - 8.5 mm



Kabelklemmbereich 6,0 - 10,0 mm cable clamping range 6.0 - 10.0 mm



Kabelklemmbereich 9,0 - 13,2 mm cable clamping range 9.0 - 13.2 mm



Kabelklemmbereich 9,0 - 14,7 mm cable clamping range 9.0 - 14.7 mm



Knopfklammung Ball Clamp

Kabelklemmbereich 5,5 - 10,5 mm cable clamping range 5.5 - 10.5 mm

Integrierte 2-Lippen-Dichtung und koaxiale Schirmanbindung
Integrated double lip seal and coaxial shield connection



Kabelklemmbereich 9,0 - 12,0 mm cable clamping range 9.0 - 12.0 mm



Auf Seite 20 finden Sie die Klemmungen für den Stecker

On page 20 you find cable clamps for the plug





A vernickelt nickel-plated

Stecker Plug

für Isolierkörper 10-polig mit Überwurfmutter M23 x 1
for insulator 10-pin with coupling nut M23 x 1

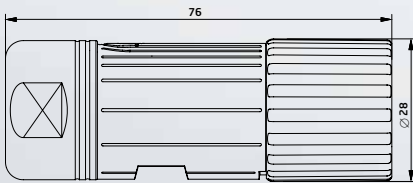

SPEEDTEC®



A vernickelt nickel-plated

Stecker Plug

für Isolierkörper 10-polig mit speedtec Schnellverschluss
for insulator 10-pin with speedtec quick lock fastener

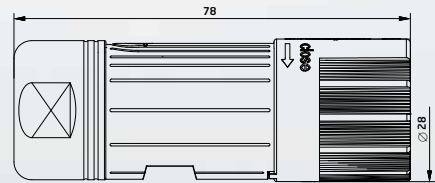

Kabelklemmungen Cable Clamps



Kronenklemmung Crown Clamp

Kabelklemmbereich 4,2 - 6,6 mm cable clamping range 4.2 - 6.6 mm

Integrierte Dichtung, Verdrehsicherung und koaxiale Kronen-Schirmanbindung.
Keine Schirmkürzung erforderlich. Integrated seal, anti-twist protection and coaxial crown shield connection. No shield trimming required.



Kabelklemmbereich 7,5 - 12,0 mm cable clamping range 7.5 - 12.0 mm



Kabelklemmbereich 9,5 - 14,5 mm cable clamping range 9.5 - 14.5 mm



Lamellenklemmung Lamella Clamp

Kabelklemmbereich 4,2 - 6,6 mm cable clamping range 4.2 - 6.6 mm

Integrierte Dichtung, Verdrehsicherung und koaxiale Schirmanbindung
Integrated seal, anti-twist protection and coaxial shield connection



Kabelklemmbereich 7,5 - 12,0 mm cable clamping range 7.5 - 12.0 mm



Kabelklemmbereich 9,5 - 14,5 mm cable clamping range 9.5 - 14.5 mm



Kabelklemmbereich 14,0 - 17,0 mm cable clamping range 14.0 - 17.0 mm



Knopfklemmung Ball Clamp

Kabelklemmbereich 9,0 - 14,0 mm cable clamping range 9.0 - 14.0 mm

Integrierte 2-Lippen-Dichtung und koaxiale Schirmanbindung.
Integrated double lip seal and coaxial shield connection.



Isolierkörper und Kontakte Insulation Inserts and Contacts



**10-polig E 10 pin E
(10 x Ø 1 mm)**

0° codiert 0° coded

Ansicht steckseitig mating view

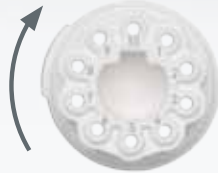

Kontaktbuchse Ø 1 mm Contact Socket Ø 1 mm
Nicht im Lieferumfang enthalten Not part of product contents



Ø 1 mm
Drahtfeder, Crimpbereich 0,14 - 1,0 mm²
wire spring, crimping range 0.14 - 1.0 mm²
60.001.11



Ø 1 mm
geschlitzt, Crimpbereich 0,14 - 1,0 mm²
slotted, crimping range 0.14 - 1.0 mm²
60.011.11



Ø 1 mm
Drahtfeder, Lötkehl 1,5 mm²
wire spring, solder bucket 1.5 mm²
60.004.11



Ø 1 mm
geschlitzt, Lötkehl 1,5 mm²
slotted, solder bucket 1.5 mm²
60.013.11



Ø 1 mm
geschlitzt, Crimpbereich 0,03 - 0,34 mm²
slotted, crimping range 0.03 - 0.34 mm²
60.172.11

Art.-Nr. Art. No.



Kontaktstift Ø 1 mm Contact Pin Ø 1 mm
Nicht im Lieferumfang enthalten Not part of product contents



Ø 1 mm
Crimpbereich 0,14 - 1,0 mm²
crimping range 0.14 - 1.0 mm²
61.004.11



Ø 1 mm
Lötkehl 1,5 mm²
solder bucket 1.5 mm²
61.006.11



Ø 1 mm
Crimpbereich 0,03 - 0,34 mm²
crimping range 0.03 - 0.34 mm²
61.083.11

Art.-Nr. Art. No.



Bandkontaktbuchse Ø 1 mm Bandoleer Contact Socket Ø 1 mm
Nicht im Lieferumfang enthalten Not part of product contents



Ø 1 mm
Crimpgröße 1 (0,03 - 0,08 mm²)
7000 Stück auf Rolle
crimping size 1 (0.03 - 0.08 mm²)
7000 pcs on reel
60.198.80



Ø 1 mm
Crimpgröße 2 (0,08 - 0,20 mm²)
7000 Stück auf Rolle
crimping size 2 (0.08 - 0.20 mm²)
7000 pcs on reel
60.199.80



Ø 1 mm
Crimpgröße 3 (0,20 - 0,52 mm²)
7000 Stück auf Rolle
crimping size 3 (0.20 - 0.52 mm²)
7000 pcs on reel
60.200.80



Ø 1 mm
Crimpgröße 4 (0,75 - 1,0 mm²)
10 000 Stück auf Rolle
crimping size 4 (0.75 - 1.0 mm²)
10000 pcs on reel
60.201.80

Art.-Nr. Art. No.



Bandkontaktstift Ø 1 mm Bandoleer Contact Pin Ø 1 mm
Nicht im Lieferumfang enthalten Not part of product contents



Ø 1 mm
Crimpgröße 1 (0,03 - 0,08 mm²)
7000 Stück auf Rolle
crimping size 1 (0.03 - 0.08 mm²)
7000 pcs on reel
61.170.80



Ø 1 mm
Crimpgröße 2 (0,08 - 0,20 mm²)
7000 Stück auf Rolle
crimping size 2 (0.08 - 0.20 mm²)
7000 pcs on reel
61.171.80



Ø 1 mm
Crimpgröße 3 (0,20 - 0,52 mm²)
7000 Stück auf Rolle
crimping size 3 (0.20 - 0.52 mm²)
7000 pcs on reel
61.172.80



Ø 1 mm
Crimpgröße 4 (0,75 - 1,0 mm²)
10 000 Stück auf Rolle
crimping size 4 (0.75 - 1.0 mm²)
10000 pcs on reel
61.173.80

Art.-Nr. Art. No.



A S T 0 3 0 0

A vernickelt nickel-plated

Stecker Plug

kurz, mit Überwurfmutter M23 x 1 für Isolierkörper 10-polig
short, with coupling nut M23 x 1 for insulator 10-pin

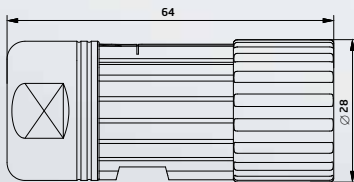

Kabelklemmungen Cable Clamps

4 3

Kronenklemmung Crown Clamp

Kabelklemmbereich 4,2 - 6,6 mm cable clamping range 4.2 - 6.6 mm

Integrierte Dichtung, Verdrehsicherung und koaxiale Kronen-Schirmanbindung.
Keine Schirmkürzung erforderlich. Integrated seal, anti-twist protection and coaxial crown shield connection. No shield trimming required.



4 8

Kabelklemmbereich 7,5 - 12,0 mm cable clamping range 7.5 - 12.0 mm

4 2

Kabelklemmbereich 9,5 - 14,5 mm cable clamping range 9.5 - 14.5 mm

1 1

Lamellenklemmung Lamella Clamp

Kabelklemmbereich 4,2 - 6,6 mm cable clamping range 4.2 - 6.6 mm

Integrierte Dichtung, Verdrehsicherung und koaxiale Schirmanbindung
Integrated seal, anti-twist protection and coaxial shield connection



5 5

Kabelklemmbereich 7,5 - 12,0 mm cable clamping range 7.5 - 12.0 mm

5 8

Kabelklemmbereich 9,5 - 14,5 mm cable clamping range 9.5 - 14.5 mm

5 9

Kabelklemmbereich 14,0 - 17,0 mm cable clamping range 14.0 - 17.0 mm

0 8

Knopfklemmung Ball Clamp

Kabelklemmbereich 9,0 - 14,0 mm cable clamping range 9.0 - 14.0 mm

Integrierte 2-Lippen-Dichtung und koaxiale Schirmanbindung.
Integrated double lip seal and coaxial shield connection.



Isolierkörper und Kontakte Insulation Inserts and Contacts



10-polig E 10-pin E (10 x Ø 1 mm)

0° codiert 0° coded

Ansicht steckseitig mating view

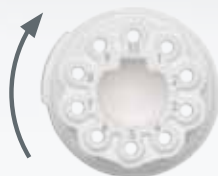

Kontaktbuchse Ø 1 mm Contact Socket Ø 1 mm Nicht im Lieferumfang enthalten Not part of product contents



Ø 1 mm

Drahtfeder, Crimpbereich 0,14 - 1,0 mm²
wire spring, crimping range 0.14 - 1.0 mm²

60.001.11



Ø 1 mm

geschlitzt, Crimpbereich 0,14 - 1,0 mm²
slotted, crimping range 0.14 - 1.0 mm²

60.011.11



Ø 1 mm

Drahtfeder, Lötkehl 1,5 mm²
wire spring, solder bucket 1.5 mm²

60.004.11



Ø 1 mm

geschlitzt, Lötkehl 1,5 mm²
slotted, solder bucket 1.5 mm²

60.013.11



Ø 1 mm

geschlitzt, Crimpbereich 0,03 - 0,34 mm²
slotted, crimping range 0.03 - 0.34 mm²

60.172.11

Art.-Nr. Art. No.



Kontaktstift Ø 1 mm Contact Pin Ø 1 mm Nicht im Lieferumfang enthalten Not part of product contents



Ø 1 mm

Crimpbereich 0,14 - 1,0 mm²
crimping range 0.14 - 1.0 mm²

61.004.11



Ø 1 mm

Lötkehl 1,5 mm²
solder bucket 1.5 mm²

61.006.11



Ø 1 mm

Crimpbereich 0,03 - 0,34 mm²
crimping range 0.03 - 0.34 mm²

61.083.11

Art.-Nr. Art. No.



Bandkontaktbuchse Ø 1 mm Bandoleer Contact Socket Ø 1 mm Nicht im Lieferumfang enthalten Not part of product contents



Ø 1 mm

Crimpgröße 1 (0,03 - 0,08 mm²)
7000 Stück auf Rolle
crimping size 1 (0.03 - 0.08 mm²)
7000 pcs on reel

60.198.80



Ø 1 mm

Crimpgröße 2 (0,08 - 0,20 mm²)
7000 Stück auf Rolle
crimping size 2 (0.08 - 0.20 mm²)
7000 pcs on reel

60.199.80



Ø 1 mm

Crimpgröße 3 (0,20 - 0,52 mm²)
7000 Stück auf Rolle
crimping size 3 (0.20 - 0.52 mm²)
7000 pcs on reel

60.200.80



Ø 1 mm

Crimpgröße 4 (0,75 - 1,0 mm²)
10 000 Stück auf Rolle
crimping size 4 (0.75 - 1.0 mm²)
10000 pcs on reel

60.201.80

Art.-Nr. Art. No.



Bandkontaktstift Ø 1 mm Bandoleer Contact Pin Ø 1 mm Nicht im Lieferumfang enthalten Not part of product contents



Ø 1 mm

Crimpgröße 1 (0,03 - 0,08 mm²)
7000 Stück auf Rolle
crimping size 1 (0.03 - 0.08 mm²)
7000 pcs on reel

61.170.80



Ø 1 mm

Crimpgröße 2 (0,08 - 0,20 mm²)
7000 Stück auf Rolle
crimping size 2 (0.08 - 0.20 mm²)
7000 pcs on reel

61.171.80



Ø 1 mm

Crimpgröße 3 (0,20 - 0,52 mm²)
7000 Stück auf Rolle
crimping size 3 (0.20 - 0.52 mm²)
7000 pcs on reel

61.172.80



Ø 1 mm

Crimpgröße 4 (0,75 - 1,0 mm²)
10 000 Stück auf Rolle
crimping size 4 (0.75 - 1.0 mm²)
10000 pcs on reel

61.173.80

Art.-Nr. Art. No.



A D F ■ ■ ■ ■ ■ ■ ■ ■ ■ ■ 00 0151 ■ ■ ■ ■

A vernickelt nickel-plated

Durchführung Bulkhead Connector

mit Überwurfmutter M23 x 1, Flanschbefestigung 25 x 25 mm, axiale O-Ring Abdichtung
with coupling nut M23 x 1, flange mount 25 x 25 mm, axial o-ring seal

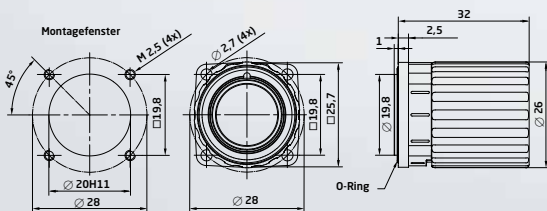

 SPEEDEC®

A D F ■ ■ ■ ■ ■ ■ ■ ■ ■ ■ 00 0101 ■ ■ ■ ■

A vernickelt nickel-plated

Durchführung Bulkhead Connector

mit speedtec Schnellverschluss, Flanschbefestigung 25 x 25 mm, axiale O-Ring Abdichtung
with speedtec quick lock fastener, flange mount 25 x 25 mm, axial o-ring seal

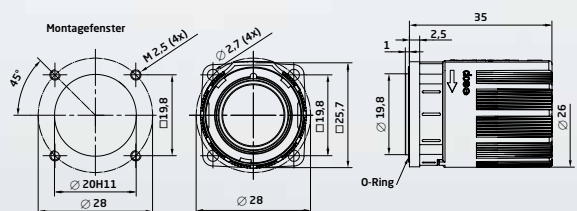

A S D ■ ■ ■ ■ ■ ■ ■ ■ ■ ■ 0150 ■ ■ ■ ■

A vernickelt nickel-plated

Winkelstecker drehbar Plug Angled rotatable

mit Überwurfmutter M23 x 1
with coupling nut M23 x 1

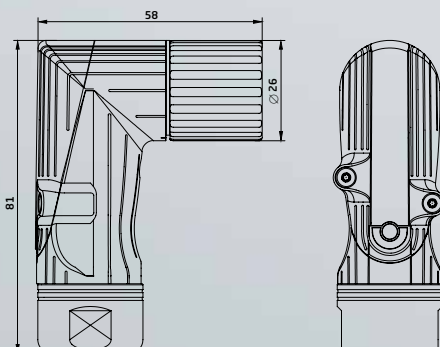

 SPEEDEC®

A S D ■ ■ ■ ■ ■ ■ ■ ■ ■ ■ 0100 ■ ■ ■ ■

A vernickelt nickel-plated

Winkelstecker drehbar Plug Angled rotatable

mit speedtec Schnellverschluss
with speedtec quick lock fastener

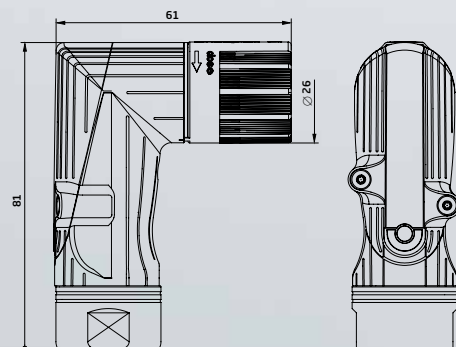

Isolierkörper und Kontakte Insulation Inserts and Contacts



6-polig P 6-pin P (6 x Ø 2 mm)

0° codiert 0° coded

Ansicht steckseitig mating view



6-polig E 6-pin E (6 x Ø 2 mm)

0° codiert 0° coded

Ansicht steckseitig mating view



7-polig P 7-pin P (7 x Ø 2 mm)

0° codiert 0° coded

Ansicht steckseitig mating view



7-polig E 7-pin E (7 x Ø 2 mm)

0° codiert 0° coded

Ansicht steckseitig mating view

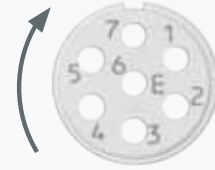

Kontaktbuchse Ø 2 mm Contact Socket Ø 2 mm Nicht im Lieferumfang enthalten Not part of product contents



Ø 2 mm
geschlitzt, Crimpbereich 0,35 - 2,5 mm²
slotted, crimping range 0.35 - 2.5 mm²
60.012.11



Ø 2 mm
geschlitzt, Lötkehl 2,5 mm²
slotted, solder bucket 2.5 mm²
60.014.11



Kontaktstift Ø 2 mm Contact Pin Ø 2 mm Nicht im Lieferumfang enthalten Not part of product contents



Ø 2 mm
Crimpereich 0,35 - 2,5 mm²
crimping range 0.35 - 2.5 mm²
61.008.11



Ø 2 mm
Lötkehl 2,5 mm²
solder bucket 2.5 mm²
61.011.11

Art.-Nr. Art. No.



9-polig P 9-pin P (9 x Ø 1 mm)

uncodiert uncoded

Ansicht steckseitig mating view

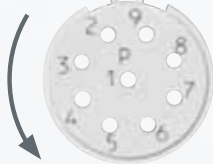

9-polig E 9-pin E (9 x Ø 1 mm)

uncodiert uncoded

Ansicht steckseitig mating view



Kontaktbuchse Ø 1 mm Contact Socket Ø 1 mm Nicht im Lieferumfang enthalten Not part of product contents



Ø 1 mm
Drahtfeder, Crimpbereich 0,14 - 1,0 mm²
wire spring, crimping range 0.14 - 1.0 mm²
60.001.11



Ø 1 mm
geschlitzt, Crimpbereich 0,14 - 1,0 mm²
slotted, crimping range 0.14 - 1.0 mm²
60.011.11



Ø 1 mm
Drahtfeder, Lötkehl 1,5 mm²
wire spring, solder bucket 1.5 mm²
60.004.11



Ø 1 mm
geschlitzt, Lötkehl 1,5 mm²
slotted, solder bucket 1.5 mm²
60.013.11



Ø 1 mm
geschlitzt, Crimpbereich 0,03 - 0,34 mm²
slotted, crimping range 0.03 - 0.34 mm²
60.172.11

Art.-Nr. Art. No.



Kontaktstift Ø 1 mm Contact Pin Ø 1 mm Nicht im Lieferumfang enthalten Not part of product contents



Ø 1 mm
Crimpereich 0,14 - 1,0 mm²
crimping range 0.14 - 1.0 mm²
61.004.11



Ø 1 mm
Lötkehl 1,5 mm²
solder bucket 1.5 mm²
61.006.11



Ø 1 mm
Crimpereich 0,03 - 0,34 mm²
crimping range 0.03 - 0.34 mm²
61.083.11

Art.-Nr. Art. No.

Isolierkörper und Kontakte

Insulation Inserts and Contacts



8+1-polig P 8+1-pin P
(8 x Ø 1 mm + 1 x Ø 2 mm)

uncodiert uncoded

Ansicht steckseitig mating view



8+1-polig E 8+1-pin E
(8 x Ø 1 mm + 1 x Ø 2 mm)

uncodiert uncoded

Ansicht steckseitig mating view

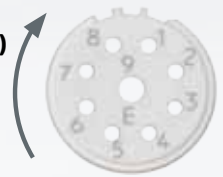

Kontaktbuchse Ø 1 mm Contact Socket Ø 1 mm
 Nicht im Lieferumfang enthalten Not part of product contents



Ø 1 mm
 Drahtfeder, Crimpbereich 0,14 - 1,0 mm²
 wire spring, crimping range 0,14 - 1,0 mm²

60.001.11



Ø 1 mm
 geschlitzt, Crimpbereich 0,14 - 1,0 mm²
 slotted, crimping range 0,14 - 1,0 mm²

60.011.11



Ø 1 mm
 Drahtfeder, Lötkehl 1,5 mm²
 wire spring, solder bucket 1,5 mm²

60.004.11



Ø 1 mm
 geschlitzt, Lötkehl 1,5 mm²
 slotted, solder bucket 1,5 mm²

60.013.11



Ø 1 mm
 geschlitzt, Crimpbereich 0,03 - 0,34 mm²
 slotted, crimping range 0,03 - 0,34 mm²

60.172.11

Art.-Nr. Art. No.



Kontaktbuchse Ø 2 mm Contact Socket Ø 2 mm
 Nicht im Lieferumfang enthalten Not part of product contents



Ø 2 mm
 geschlitzt, Crimpbereich 0,35 - 2,5 mm²
 slotted, crimping range 0,35 - 2,5 mm²

60.012.11



Ø 2 mm
 geschlitzt, Lötkehl 2,5 mm²
 slotted, solder bucket 2,5 mm²

60.014.11

Art.-Nr. Art. No.



Kontaktstift Ø 1 mm Contact Pin Ø 1 mm
 Nicht im Lieferumfang enthalten Not part of product contents



Ø 1 mm
 Crimpbereich 0,14 - 1,0 mm²
 crimping range 0,14 - 1,0 mm²

61.004.11



Ø 1 mm
 Lötkehl 1,5 mm²
 solder bucket 1,5 mm²

61.006.11



Ø 1 mm
 Crimpbereich 0,03 - 0,34 mm²
 crimping range 0,03 - 0,34 mm²

61.083.11

Art.-Nr. Art. No.



Kontaktstift Ø 2 mm Contact Pin Ø 2 mm
 Nicht im Lieferumfang enthalten Not part of product contents



Ø 2 mm
 Crimpbereich 0,35 - 2,5 mm²
 crimping range 0,35 - 2,5 mm²

61.008.11



Ø 2 mm
 Lötkehl 2,5 mm²
 solder bucket 2,5 mm²

61.011.11

Insulation Inserts and Contacts



12-polig P 12-pin P (12 x Ø 1 mm)

0° codiert 0° coded

Ansicht steckseitig mating view



12-polig E 12-pin E (12 x Ø 1 mm)

0° codiert 0° coded

Ansicht steckseitig mating view

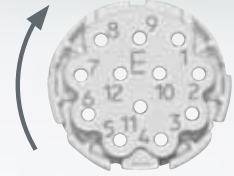

17-polig P 17-pin P (17 x Ø 1 mm)

0° codiert 0° coded

Ansicht steckseitig mating view



17-polig E 17-pin E (17 x Ø 1 mm)

0° codiert 0° coded

Ansicht steckseitig mating view

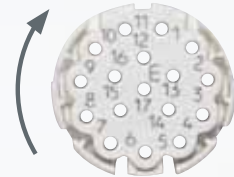

Kontaktbuchse Ø 1 mm Contact Socket Ø 1 mm Nicht im Lieferumfang enthalten Not part of product contents



Ø 1 mm
Drahtfeder, Crimpbereich 0,14 - 1,0 mm²
wire spring, crimping range 0.14 - 1.0 mm²
60.001.11



Ø 1 mm
geschlitzt, Crimpbereich 0,14 - 1,0 mm²
slotted, crimping range 0.14 - 1.0 mm²
60.011.11



Ø 1 mm
Drahtfeder, Lötkelch 1,5 mm²
wire spring, solder bucket 1.5 mm²
60.004.11



Ø 1 mm
geschlitzt, Lötkelch 1,5 mm²
slotted, solder bucket 1.5 mm²
60.013.11



Ø 1 mm
geschlitzt, Crimpbereich 0,03 - 0,34 mm²
slotted, crimping range 0.03 - 0.34 mm²
60.172.11

Art.-Nr. Art. No.



Kontaktstift Ø 1 mm Contact Pin Ø 1 mm Nicht im Lieferumfang enthalten Not part of product contents



Ø 1 mm
Crimpbereich 0,14 - 1,0 mm²
crimping range 0.14 - 1.0 mm²
61.004.11



Ø 1 mm
Lötkelch 1,5 mm²
solder bucket 1.5 mm²
61.006.11



Ø 1 mm
Crimpbereich 0,03 - 0,34 mm²
crimping range 0.03 - 0.34 mm²
61.083.11

Art.-Nr. Art. No.



Bandkontaktbuchse Ø 1 mm Bandoleer Contact Socket Ø 1 mm Nicht im Lieferumfang enthalten Not part of product contents



Ø 1 mm
Crimprgröße 1 (0,03 - 0,08 mm²)
7000 Stück auf Rolle
crimping size 1 (0.03 - 0.08 mm²)
7000 pcs on reel
60.198.80



Ø 1 mm
Crimprgröße 2 (0,08 - 0,20 mm²)
7000 Stück auf Rolle
crimping size 2 (0.08 - 0.20 mm²)
7000 pcs on reel
60.199.80



Ø 1 mm
Crimprgröße 3 (0,20 - 0,52 mm²)
7000 Stück auf Rolle
crimping size 3 (0.20 - 0.52 mm²)
7000 pcs on reel
60.200.80



Ø 1 mm
Crimprgröße 4 (0,75 - 1,0 mm²)
10000 Stück auf Rolle
crimping size 4 (0.75 - 1.0 mm²)
10000 pcs on reel
60.201.80

Art.-Nr. Art. No.



Bandkontaktstift Ø 1 mm Bandoleer Contact Pin Ø 1 mm Nicht im Lieferumfang enthalten Not part of product contents



Ø 1 mm
Crimprgröße 1 (0,03 - 0,08 mm²)
7000 Stück auf Rolle
crimping size 1 (0.03 - 0.08 mm²)
7000 pcs on reel
61.170.80



Ø 1 mm
Crimprgröße 2 (0,08 - 0,20 mm²)
7000 Stück auf Rolle
crimping size 2 (0.08 - 0.20 mm²)
7000 pcs on reel
61.171.80



Ø 1 mm
Crimprgröße 3 (0,20 - 0,52 mm²)
7000 Stück auf Rolle
crimping size 3 (0.20 - 0.52 mm²)
7000 pcs on reel
61.172.80



Ø 1 mm
Crimprgröße 4 (0,75 - 1,0 mm²)
10000 Stück auf Rolle
crimping size 4 (0.75 - 1.0 mm²)
10000 pcs on reel
61.173.80

Art.-Nr. Art. No.

Isolierkörper und Kontakte Insulation Inserts and Contacts



16+3-polig P 16+3-pin P (16 x Ø 1 mm + 3 x Ø 1,5 mm)

0° codiert 0° coded

Ansicht steckseitig mating view

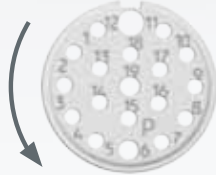

16+3-polig E 16+3-pin E (16 x Ø 1 mm + 3 x Ø 1,5 mm)

0° codiert 0° coded

Ansicht steckseitig mating view

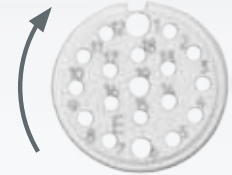

Kontaktbuchse Ø 1 mm Contact Socket Ø 1 mm Nicht im Lieferumfang enthalten Not part of product contents



Ø 1 mm

Drahtfeder, Crimpbereich 0,14 - 1,0 mm²
wire spring, crimping range 0.14 - 1.0 mm²

Art.-Nr. Art. No. 60.001.11



Ø 1 mm

geschlitzt, Crimpbereich 0,14 - 1,0 mm²
slotted, crimping range 0.14 - 1.0 mm²

60.011.11



Ø 1 mm

Drahtfeder, Lötkelch 1,5 mm²
wire spring, solder bucket 1.5 mm²

60.004.11



Ø 1 mm

geschlitzt, Lötkelch 1,5 mm²
slotted, solder bucket 1.5 mm²

60.013.11



Ø 1 mm

geschlitzt, Crimpbereich 0,03 - 0,34 mm²
slotted, crimping range 0.03 - 0.34 mm²

60.172.11



Kontaktbuchse Ø 1,5 mm Contact Socket Ø 1,5 mm Nicht im Lieferumfang enthalten Not part of product contents



Ø 1,5 mm

geschlitzt, Crimpbereich 0,24 - 1,0 mm²
slotted, crimping range 0.24 - 1.0 mm²

Art.-Nr. Art. No. 60.070.11



Ø 1,5 mm

geschlitzt, Lötkelch 1,5 mm²
slotted, solder bucket 1.5 mm²

60.173.11



Kontaktstift Ø 1 mm Contact Pin Ø 1 mm Nicht im Lieferumfang enthalten Not part of product contents



Ø 1 mm

Crimpereich 0,14 - 1,0 mm²
crimping range 0.14 - 1.0 mm²

Art.-Nr. Art. No. 61.004.11



Ø 1 mm

Lötkelch 1,5 mm²
solder bucket 1.5 mm²

61.006.11



Ø 1 mm

Crimpereich 0,03 - 0,34 mm²
crimping range 0.03 - 0.34 mm²

61.083.11



Ø 1,5 mm

Crimpereich 0,24 - 1,0 mm²
crimping range 0.24 - 1.0 mm²

Art.-Nr. Art. No. 61.072.11



Ø 1,5 mm

Lötkelch 1,5 mm²
solder bucket 1.5 mm²

61.152.11



Bandkontaktbuchse Ø 1 mm Bandoleer Contact Socket Ø 1 mm Nicht im Lieferumfang enthalten Not part of product contents



Ø 1 mm

Crimpgröße 1 (0,03 - 0,08 mm²)
7000 Stück auf Rolle
crimping size 1 (0.03 - 0.08 mm²)
7000 pcs on reel

Art.-Nr. Art. No. 60.198.80



Ø 1 mm

Crimpgröße 2 (0,08 - 0,20 mm²)
7000 Stück auf Rolle
crimping size 2 (0.08 - 0.20 mm²)
7000 pcs on reel

60.199.80



Ø 1 mm

Crimpgröße 3 (0,20 - 0,52 mm²)
7000 Stück auf Rolle
crimping size 3 (0.20 - 0.52 mm²)
7000 pcs on reel

60.200.80



Ø 1 mm

Crimpgröße 4 (0,75 - 1,0 mm²)
10000 Stück auf Rolle
crimping size 4 (0.75 - 1.0 mm²)
10000 pcs on reel

60.201.80



Bandkontaktstift Ø 1 mm Bandoleer Contact Pin Ø 1 mm Nicht im Lieferumfang enthalten Not part of product contents



Ø 1 mm

Crimpgröße 1 (0,03 - 0,08 mm²)
7000 Stück auf Rolle
crimping size 1 (0.03 - 0.08 mm²)
7000 pcs on reel

Art.-Nr. Art. No. 61.170.80

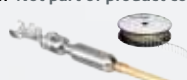

Ø 1 mm

Crimpgröße 2 (0,08 - 0,20 mm²)
7000 Stück auf Rolle
crimping size 2 (0.08 - 0.20 mm²)
7000 pcs on reel

61.171.80



Ø 1 mm

Crimpgröße 3 (0,20 - 0,52 mm²)
7000 Stück auf Rolle
crimping size 3 (0.20 - 0.52 mm²)
7000 pcs on reel

61.172.80



Ø 1 mm

Crimpgröße 4 (0,75 - 1,0 mm²)
10000 Stück auf Rolle
crimping size 4 (0.75 - 1.0 mm²)
10000 pcs on reel

61.173.80

Kabelklemmungen Cable Clamps



Kronenklemmung Crown Clamp

Kabelklemmbereich 4,2 - 6,6 mm cable clamping range 4.2 - 6.6 mm

Integrierte Dichtung, Verdrehsicherung und koaxiale Kronen-Schirmanbindung.
Keine Schirmkürzung erforderlich. Integrated seal, anti-twist protection and coaxial crown shield connection. No shield trimming required.

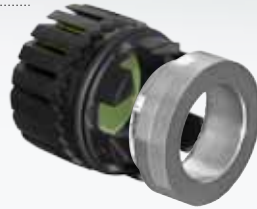

Kabelklemmbereich 7,5 - 12,0 mm cable clamping range 7.5 - 12.0 mm



Kabelklemmbereich 9,5 - 14,5 mm cable clamping range 9.5 - 14.5 mm



Lamellenklemmung Lamella Clamp

Kabelklemmbereich 4,2 - 6,6 mm cable clamping range 4.2 - 6.6 mm

Integrierte Dichtung, Verdrehsicherung und koaxiale Schirmanbindung
Integrated seal, anti-twist protection and coaxial shield connection



Kabelklemmbereich 7,5 - 12,0 mm cable clamping range 7.5 - 12.0 mm



Kabelklemmbereich 9,5 - 14,5 mm cable clamping range 9.5 - 14.5 mm



Kabelklemmbereich 14,0 - 17,0 mm cable clamping range 14.0 - 17.0 mm



Knopfklemmung Ball Clamp

Kabelklemmbereich 9,0 - 14,0 mm cable clamping range 9.0 - 14.0 mm

Integrierte 2-Lippen-Dichtung und koaxiale Schirmanbindung.
Integrated double lip seal and coaxial shield connection.





SPEEDTEC®



A K U ■ ■ ■ ■ ■ ■ ■ ■ ■ ■ 0 2 0 0 ■ ■ ■ ■

A vernickelt nickel-plated

Kupplung Extension

mit Aussengewinde M23 x 1 und Vibrationsschutz-O-Ring, speedtec-ready
with outside thread M23 x 1 and anti-vibration o-ring, speedtec-ready

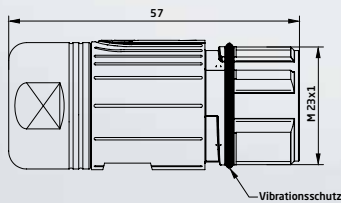

A K U ■ ■ ■ ■ ■ ■ ■ ■ ■ ■ 0 1 0 0 ■ ■ ■ ■

A vernickelt nickel-plated

Kupplung Extension

für speedtec Schnellverschluss
for speedtec quick lock fastener

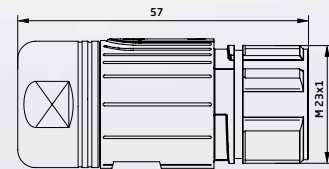

SPEEDTEC®



A K U ■ ■ ■ ■ ■ ■ ■ ■ ■ ■ 0 2 5 5 ■ ■ ■ ■

A vernickelt nickel-plated

Kupplung Extension

Ø 25 mm mit Aussengewinde M23 x 1 und Vibrationsschutz-O-Ring, speedtec-ready für Busanwendungen
Ø 25 mm with outside thread M23 x 1 and anti-vibration o-ring, speedtec-ready for bus applications

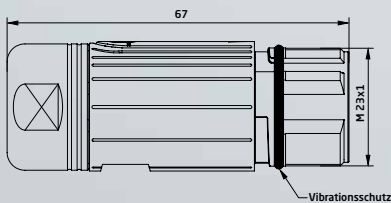

A K U ■ ■ ■ ■ ■ ■ ■ ■ ■ ■ 0 1 5 5 ■ ■ ■ ■

A vernickelt nickel-plated

Kupplung Extension

Ø 25 mm für speedtec Schnellverschluss und Busanwendungen
Ø 25 mm for speedtec quick lock fastener and bus applications

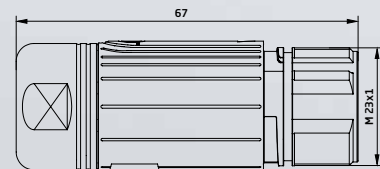

Isolierkörper und Kontakte Insulation Inserts and Contacts

151

6-polig P 6-pin P (6 x Ø 2 mm)

0° codiert 0° coded

Ansicht steckseitig mating view

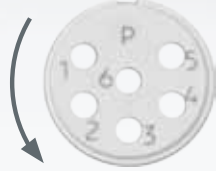

152

6-polig E 6-pin E (6 x Ø 2 mm)

0° codiert 0° coded

Ansicht steckseitig mating view



157

7-polig P 7-pin P (7 x Ø 2 mm)

0° codiert 0° coded

Ansicht steckseitig mating view



158

7-polig E 7-pin E (7 x Ø 2 mm)

0° codiert 0° coded

Ansicht steckseitig mating view

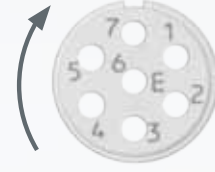

NN 00

Kontaktbuchse Ø 2 mm Contact Socket Ø 2 mm Nicht im Lieferumfang enthalten Not part of product contents



Ø 2 mm
geschlitzt, Crimpbereich 0,35 - 2,5 mm²
slotted, crimping range 0.35 - 2.5 mm²
60.012.11



Ø 2 mm
geschlitzt, Lötkegel 2,5 mm²
slotted, solder bucket 2.5 mm²
60.014.11

NN 00

Kontaktstift Ø 2 mm Contact Pin Ø 2 mm Nicht im Lieferumfang enthalten Not part of product contents



Ø 2 mm
Crimpereich 0,35 - 2,5 mm²
crimping range 0.35 - 2.5 mm²
61.008.11



Ø 2 mm
Lötkegel 2,5 mm²
solder bucket 2.5 mm²
61.011.11

Art.-Nr. Art. No.

055

9-polig P 9-pin P (9 x Ø 1 mm)

uncodiert uncodet

Ansicht steckseitig mating view

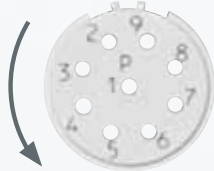

054

9-polig E 9-pin E (9 x Ø 1 mm)

uncodiert uncodet

Ansicht steckseitig mating view

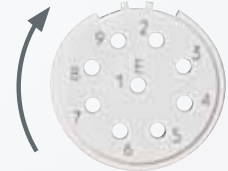

NN 00

Kontaktbuchse Ø 1 mm Contact Socket Ø 1 mm Nicht im Lieferumfang enthalten Not part of product contents



Ø 1 mm
Drahtfeder, Crimpbereich 0,14 - 1,0 mm²
wire spring, crimping range 0.14 - 1.0 mm²
60.001.11



Ø 1 mm
geschlitzt, Crimpbereich 0,14 - 1,0 mm²
slotted, crimping range 0.14 - 1.0 mm²
60.011.11



Ø 1 mm
Drahtfeder, Lötkegel 1,5 mm²
wire spring, solder bucket 1.5 mm²
60.004.11



Ø 1 mm
geschlitzt, Lötkegel 1,5 mm²
slotted, solder bucket 1.5 mm²
60.013.11



Ø 1 mm
geschlitzt, Crimpbereich 0,03 - 0,34 mm²
slotted, crimping range 0.03 - 0.34 mm²
60.172.11

Art.-Nr. Art. No.

NN 00

Kontaktstift Ø 1 mm Contact Pin Ø 1 mm Nicht im Lieferumfang enthalten Not part of product contents



Ø 1 mm
Crimpereich 0,14 - 1,0 mm²
crimping range 0.14 - 1.0 mm²
61.004.11



Ø 1 mm
Lötkegel 1,5 mm²
solder bucket 1.5 mm²
61.006.11



Ø 1 mm
Crimpereich 0,03 - 0,34 mm²
crimping range 0.03 - 0.34 mm²
61.083.11

Art.-Nr. Art. No.

Isolierkörper und Kontakte

Insulation Inserts and Contacts

070

8+1-polig P 8+1-pin P
(8 x Ø 1 mm + 1 x Ø 2 mm)

uncodiert uncodet

Ansicht steckseitig mating view



071

8+1-polig E 8+1-pin E
(8 x Ø 1 mm + 1 x Ø 2 mm)

uncodiert uncodet

Ansicht steckseitig mating view

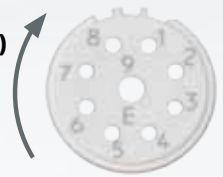

NN 00

Kontaktbuchse Ø 1 mm Contact Socket Ø 1 mm
Nicht im Lieferumfang enthalten Not part of product contents



Ø 1 mm
Drahtfeder, Crimpbereich 0,14 - 1,0 mm²
wire spring, crimping range 0.14 - 1.0 mm²

60.001.11



Ø 1 mm
geschlitzt, Crimpbereich 0,14 - 1,0 mm²
slotted, crimping range 0.14 - 1.0 mm²

60.011.11



Ø 1 mm
Drahtfeder, Lötkehl 1,5 mm²
wire spring, solder bucket 1.5 mm²

60.004.11



Ø 1 mm
geschlitzt, Lötkehl 1,5 mm²
slotted, solder bucket 1.5 mm²

60.013.11



Ø 1 mm
geschlitzt, Crimpbereich 0,03 - 0,34 mm²
slotted, crimping range 0.03 - 0.34 mm²

60.172.11

NN 00

Kontaktbuchse Ø 2 mm Contact Socket Ø 2 mm
Nicht im Lieferumfang enthalten Not part of product contents



Ø 2 mm
geschlitzt, Crimpbereich 0,35 - 2,5 mm²
slotted, crimping range 0.35 - 2.5 mm²

60.012.11



Ø 2 mm
geschlitzt, Lötkehl 2,5 mm²
slotted, solder bucket 2.5 mm²

60.014.11

NN 00

Kontaktstift Ø 1 mm Contact Pin Ø 1 mm
Nicht im Lieferumfang enthalten Not part of product contents



Ø 1 mm
Crimpbereich 0,14 - 1,0 mm²
crimping range 0.14 - 1.0 mm²

61.004.11



Ø 1 mm
Lötkehl 1,5 mm²
solder bucket 1.5 mm²

61.006.11



Ø 1 mm
Crimpbereich 0,03 - 0,34 mm²
crimping range 0.03 - 0.34 mm²

61.083.11



Ø 2 mm
Crimpbereich 0,35 - 2,5 mm²
crimping range 0.35 - 2.5 mm²

61.008.11



Ø 2 mm
Lötkehl 2,5 mm²
solder bucket 2.5 mm²

61.011.11

Insulation Inserts and Contacts



12-polig P 12-pin P (12 x Ø 1 mm)

0° codiert 0° coded

Ansicht steckseitig mating view



12-polig E 12-pin E (12 x Ø 1 mm)

0° codiert 0° coded

Ansicht steckseitig mating view

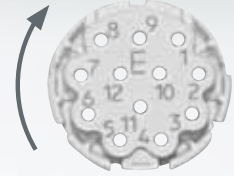

17-polig P 17-pin P (17 x Ø 1 mm)

0° codiert 0° coded

Ansicht steckseitig mating view



17-polig E 17-pin E (17 x Ø 1 mm)

0° codiert 0° coded

Ansicht steckseitig mating view

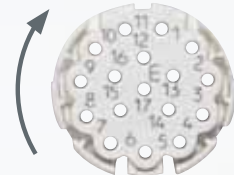

Kontaktbuchse Ø 1 mm Contact Socket Ø 1 mm Nicht im Lieferumfang enthalten Not part of product contents



Ø 1 mm
Drahtfeder, Crimpbereich 0,14 - 1,0 mm²
wire spring, crimping range 0.14 - 1.0 mm²
60.001.11



Ø 1 mm
geschlitzt, Crimpbereich 0,14 - 1,0 mm²
slotted, crimping range 0.14 - 1.0 mm²
60.011.11



Ø 1 mm
Drahtfeder, Lötkelch 1,5 mm²
wire spring, solder bucket 1.5 mm²
60.004.11



Ø 1 mm
geschlitzt, Lötkelch 1,5 mm²
slotted, solder bucket 1.5 mm²
60.013.11



Ø 1 mm
geschlitzt, Crimpbereich 0,03 - 0,34 mm²
slotted, crimping range 0.03 - 0.34 mm²
60.172.11

Art.-Nr. Art. No.



Kontaktstift Ø 1 mm Contact Pin Ø 1 mm Nicht im Lieferumfang enthalten Not part of product contents



Ø 1 mm
Crimpbereich 0,14 - 1,0 mm²
crimping range 0.14 - 1.0 mm²
61.004.11



Ø 1 mm
Lötkelch 1,5 mm²
solder bucket 1.5 mm²
61.006.11



Ø 1 mm
Crimpbereich 0,03 - 0,34 mm²
crimping range 0.03 - 0.34 mm²
61.083.11

Art.-Nr. Art. No.



Bandkontaktbuchse Ø 1 mm Bandoleer Contact Socket Ø 1 mm Nicht im Lieferumfang enthalten Not part of product contents



Ø 1 mm
Crimprgröße 1 (0,03 - 0,08 mm²)
7000 Stück auf Rolle
crimping size 1 (0.03 - 0.08 mm²)
7000 pcs on reel
60.198.80



Ø 1 mm
Crimprgröße 2 (0,08 - 0,20 mm²)
7000 Stück auf Rolle
crimping size 2 (0.08 - 0.20 mm²)
7000 pcs on reel
60.199.80



Ø 1 mm
Crimprgröße 3 (0,20 - 0,52 mm²)
7000 Stück auf Rolle
crimping size 3 (0.20 - 0.52 mm²)
7000 pcs on reel
60.200.80



Ø 1 mm
Crimprgröße 4 (0,75 - 1,0 mm²)
10000 Stück auf Rolle
crimping size 4 (0.75 - 1.0 mm²)
10000 pcs on reel
60.201.80

Art.-Nr. Art. No.



Bandkontaktstift Ø 1 mm Bandoleer Contact Pin Ø 1 mm Nicht im Lieferumfang enthalten Not part of product contents



Ø 1 mm
Crimprgröße 1 (0,03 - 0,08 mm²)
7000 Stück auf Rolle
crimping size 1 (0.03 - 0.08 mm²)
7000 pcs on reel
61.170.80



Ø 1 mm
Crimprgröße 2 (0,08 - 0,20 mm²)
7000 Stück auf Rolle
crimping size 2 (0.08 - 0.20 mm²)
7000 pcs on reel
61.171.80



Ø 1 mm
Crimprgröße 3 (0,20 - 0,52 mm²)
7000 Stück auf Rolle
crimping size 3 (0.20 - 0.52 mm²)
7000 pcs on reel
61.172.80



Ø 1 mm
Crimprgröße 4 (0,75 - 1,0 mm²)
10000 Stück auf Rolle
crimping size 4 (0.75 - 1.0 mm²)
10000 pcs on reel
61.173.80

Art.-Nr. Art. No.

Isolierkörper und Kontakte Insulation Inserts and Contacts

558

16+3-polig P 16+3-pin P (16 x Ø 1 mm + 3 x Ø 1,5 mm)

0° codiert 0° coded

Ansicht steckseitig mating view

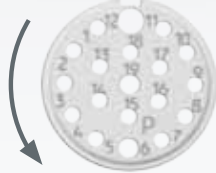

559

16+3-polig E 16+3-pin E (16 x Ø 1 mm + 3 x Ø 1,5 mm)

0° codiert 0° coded

Ansicht steckseitig mating view

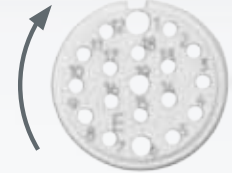

NN 00

Kontaktbuchse Ø 1 mm Contact Socket Ø 1 mm

Nicht im Lieferumfang enthalten Not part of product contents



Ø 1 mm

Drahtfeder, Crimpbereich 0,14 - 1,0 mm²
wire spring, crimping range 0.14 - 1.0 mm²

Art.-Nr. Art. No. 60.001.11



Ø 1 mm

geschlitzt, Crimpbereich 0,14 - 1,0 mm²
slotted, crimping range 0.14 - 1.0 mm²

Art.-Nr. Art. No. 60.011.11



Ø 1 mm

Drahtfeder, Lötkehl 1,5 mm²
wire spring, solder bucket 1.5 mm²

Art.-Nr. Art. No. 60.004.11



Ø 1 mm

geschlitzt, Lötkehl 1,5 mm²
slotted, solder bucket 1.5 mm²

Art.-Nr. Art. No. 60.013.11



Ø 1 mm

geschlitzt, Crimpbereich 0,03 - 0,34 mm²
slotted, crimping range 0.03 - 0.34 mm²

Art.-Nr. Art. No. 60.172.11

NN 00

Kontaktbuchse Ø 1,5 mm Contact Socket Ø 1,5 mm

Nicht im Lieferumfang enthalten Not part of product contents



Ø 1,5 mm

geschlitzt, Crimpbereich 0,24 - 1,0 mm²
slotted, crimping range 0.24 - 1.0 mm²

Art.-Nr. Art. No. 60.070.11

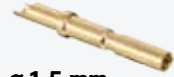

Ø 1,5 mm

geschlitzt, Lötkehl 1,5 mm²
slotted, solder bucket 1.5 mm²

Art.-Nr. Art. No. 60.173.11

NN 00

Kontaktstift Ø 1 mm Contact Pin Ø 1 mm

Nicht im Lieferumfang enthalten Not part of product contents



Ø 1 mm

Crimpereich 0,14 - 1,0 mm²
crimping range 0.14 - 1.0 mm²

Art.-Nr. Art. No. 61.004.11



Ø 1 mm

Lötkehl 1,5 mm²
solder bucket 1.5 mm²

Art.-Nr. Art. No. 61.006.11



Ø 1 mm

Crimpereich 0,03 - 0,34 mm²
crimping range 0.03 - 0.34 mm²

Art.-Nr. Art. No. 61.083.11



Ø 1,5 mm

Crimpereich 0,24 - 1,0 mm²
crimping range 0.24 - 1.0 mm²

Art.-Nr. Art. No. 61.072.11



Ø 1,5 mm

Lötkehl 1,5 mm²
solder bucket 1.5 mm²

Art.-Nr. Art. No. 61.152.11

NN 00

Bandkontaktbuchse Ø 1 mm Bandoleer Contact Socket Ø 1 mm

Nicht im Lieferumfang enthalten Not part of product contents



Ø 1 mm

Crimpgröße 1 (0,03 - 0,08 mm²)
7000 Stück auf Rolle
crimping size 1 (0.03 - 0.08 mm²)
7000 pcs on reel

Art.-Nr. Art. No. 60.198.80



Ø 1 mm

Crimpgröße 2 (0,08 - 0,20 mm²)
7000 Stück auf Rolle
crimping size 2 (0.08 - 0.20 mm²)
7000 pcs on reel

Art.-Nr. Art. No. 60.199.80



Ø 1 mm

Crimpgröße 3 (0,20 - 0,52 mm²)
7000 Stück auf Rolle
crimping size 3 (0.20 - 0.52 mm²)
7000 pcs on reel

Art.-Nr. Art. No. 60.200.80



Ø 1 mm

Crimpgröße 4 (0,75 - 1,0 mm²)
10000 Stück auf Rolle
crimping size 4 (0.75 - 1.0 mm²)
10000 pcs on reel

Art.-Nr. Art. No. 60.201.80

NN 00

Bandkontaktstift Ø 1 mm Bandoleer Contact Pin Ø 1 mm

Nicht im Lieferumfang enthalten Not part of product contents



Ø 1 mm

Crimpgröße 1 (0,03 - 0,08 mm²)
7000 Stück auf Rolle
crimping size 1 (0.03 - 0.08 mm²)
7000 pcs on reel

Art.-Nr. Art. No. 61.170.80



Ø 1 mm

Crimpgröße 2 (0,08 - 0,20 mm²)
7000 Stück auf Rolle
crimping size 2 (0.08 - 0.20 mm²)
7000 pcs on reel

Art.-Nr. Art. No. 61.171.80



Ø 1 mm

Crimpgröße 3 (0,20 - 0,52 mm²)
7000 Stück auf Rolle
crimping size 3 (0.20 - 0.52 mm²)
7000 pcs on reel

Art.-Nr. Art. No. 61.172.80



Ø 1 mm

Crimpgröße 4 (0,75 - 1,0 mm²)
10000 Stück auf Rolle
crimping size 4 (0.75 - 1.0 mm²)
10000 pcs on reel

Art.-Nr. Art. No. 61.173.80

Kabelklemmungen Cable Clamps



Kronenklemmung Crown Clamp

Kabelklemmbereich 3,5 - 5,6 mm cable clamping range 3.5 - 5.6 mm

Integrierte Dichtung, Verdrehsicherung und koaxiale Kronen-Schirmanbindung
Keine Schirmkürzung erforderlich

Integrated sealing, anti-twist protection and coaxial crown shield connection
No shield trimming required



Kabelklemmbereich 4,5 - 8,5 mm cable clamping range 4.5 - 8.5 mm



Kabelklemmbereich 6,0 - 10,0 mm cable clamping range 6.0 - 10.0 mm



Kabelklemmbereich 9,0 - 13,2 mm cable clamping range 9.0 - 13.2 mm



Kabelklemmbereich 9,0 - 14,7 mm cable clamping range 9.0 - 14.7 mm



Lamellenklemmung Lamella Clamp

Kabelklemmbereich 3,5 - 5,6 mm cable clamping range 3.5 - 5.6 mm

Integrierte Dichtung, Verdrehsicherung und koaxiale Schirmanbindung.
Integrierte sealing, anti-twist protection and coaxial shield connection.



Kabelklemmbereich 4,5 - 8,5 mm cable clamping range 4.5 - 8.5 mm



Kabelklemmbereich 6,0 - 10,0 mm cable clamping range 6.0 - 10.0 mm



Kabelklemmbereich 9,0 - 13,2 mm cable clamping range 9.0 - 13.2 mm



Kabelklemmbereich 9,0 - 14,7 mm cable clamping range 9.0 - 14.7 mm



Knopfklammer Ball Clamp

Kabelklemmbereich 5,5 - 10,5 mm cable clamping range 5.5 - 10.5 mm

Integrierte 2-Lippen-Dichtung und koaxiale Schirmanbindung
Integrated double lip seal and coaxial shield connection



Kabelklemmbereich 9,0 - 12,0 mm cable clamping range 9.0 - 12.0 mm



Auf Seite 42 finden Sie die Klemmungen für die Kupplung
On page 42 you find cable clamps for the extension





A vernickelt nickel-plated

Kupplung Extension

für Isolierkörper 10-polig mit Aussengewinde M23 x 1 und Vibrationsschutz-O-Ring, speedtec-ready
for insulation insert 10-pin with outside thread M23 x 1 and anti-vibration o-ring, speedtec-ready

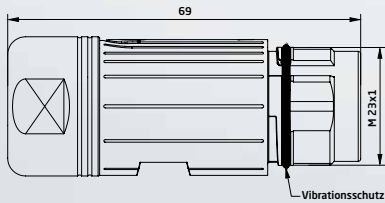

A vernickelt nickel-plated

Kupplung Extension

für Isolierkörper 10-polig und speedtec Schnellverschluss
for insulation insert 10-pin and speedtec quick lock fastener

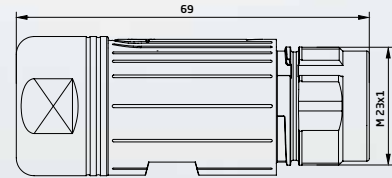

Kabelklemmungen Cable Clamps



Kronenklemmung Crown Clamp

Kabelklemmbereich 4,2 - 6,6 mm cable clamping range 4.2 - 6.6 mm

Integrierte Dichtung, Verdrehsicherung und koaxiale Kronen-Schirmanbindung.
Keine Schirmkürzung erforderlich. Integrated seal, anti-twist protection and coaxial crown shield connection. No shield trimming required.



Kabelklemmbereich 7,5 - 12,0 mm cable clamping range 7.5 - 12.0 mm



Kabelklemmbereich 9,5 - 14,5 mm cable clamping range 9.5 - 14.5 mm



Lamellenklemmung Lamella Clamp

Kabelklemmbereich 4,2 - 6,6 mm cable clamping range 4.2 - 6.6 mm

Integrierte Dichtung, Verdrehsicherung und koaxiale Schirmanbindung
Integrated seal, anti-twist protection and coaxial shield connection



Kabelklemmbereich 7,5 - 12,0 mm cable clamping range 7.5 - 12.0 mm



Kabelklemmbereich 9,5 - 14,5 mm cable clamping range 9.5 - 14.5 mm



Kabelklemmbereich 14,0 - 17,0 mm cable clamping range 14.0 - 17.0 mm



Knopfklammung Ball Clamp

Kabelklemmbereich 9,0 - 14,0 mm cable clamping range 9.0 - 14.0 mm

Integrierte 2-Lippen-Dichtung und koaxiale Schirmanbindung.
Integrated double lip seal and coaxial shield connection.



Isolierkörper und Kontakte Insulation Inserts and Contacts



10-polig P 10-pin P (10 x Ø 1 mm)

0° codiert 0° coded

Ansicht steckseitig mating view



Kontaktbuchse Ø 1 mm Contact Socket Ø 1 mm Nicht im Lieferumfang enthalten Not part of product contents



Ø 1 mm
Drahtfeder, Crimpbereich 0,14 - 1,0 mm²
wire spring, crimping range 0.14 - 1.0 mm²
60.001.11



Ø 1 mm
geschlitzt, Crimpbereich 0,14 - 1,0 mm²
slotted, crimping range 0.14 - 1.0 mm²
60.011.11



Ø 1 mm
Drahtfeder, Lötkehl 1,5 mm²
wire spring, solder bucket 1.5 mm²
60.004.11



Ø 1 mm
geschlitzt, Lötkehl 1,5 mm²
slotted, solder bucket 1.5 mm²
60.013.11



Ø 1 mm
geschlitzt, Crimpbereich 0,03 - 0,34 mm²
slotted, crimping range 0.03 - 0.34 mm²
60.172.11

Art.-Nr. Art. No.



Kontaktstift Ø 1 mm Contact Pin Ø 1 mm Nicht im Lieferumfang enthalten Not part of product contents



Ø 1 mm
Crimpbereich 0,14 - 1,0 mm²
crimping range 0.14 - 1.0 mm²
61.004.11



Ø 1 mm
Lötkehl 1,5 mm²
solder bucket 1.5 mm²
61.006.11



Ø 1 mm
Crimpbereich 0,03 - 0,34 mm²
crimping range 0.03 - 0.34 mm²
61.083.11

Art.-Nr. Art. No.



Bandkontaktbuchse Ø 1 mm Bandoleer Contact Socket Ø 1 mm Nicht im Lieferumfang enthalten Not part of product contents



Ø 1 mm
Crimpgröße 1 (0,03 - 0,08 mm²)
7000 Stück auf Rolle
crimping size 1 (0.03 - 0.08 mm²)
7000 pcs on reel
60.198.80



Ø 1 mm
Crimpgröße 2 (0,08 - 0,20 mm²)
7000 Stück auf Rolle
crimping size 2 (0.08 - 0.20 mm²)
7000 pcs on reel
60.199.80



Ø 1 mm
Crimpgröße 3 (0,20 - 0,52 mm²)
7000 Stück auf Rolle
crimping size 3 (0.20 - 0.52 mm²)
7000 pcs on reel
60.200.80



Ø 1 mm
Crimpgröße 4 (0,75 - 1,0 mm²)
10 000 Stück auf Rolle
crimping size 4 (0.75 - 1.0 mm²)
10000 pcs on reel
60.201.80

Art.-Nr. Art. No.



Bandkontaktstift Ø 1 mm Bandoleer Contact Pin Ø 1 mm Nicht im Lieferumfang enthalten Not part of product contents



Ø 1 mm
Crimpgröße 1 (0,03 - 0,08 mm²)
7000 Stück auf Rolle
crimping size 1 (0.03 - 0.08 mm²)
7000 pcs on reel
61.170.80



Ø 1 mm
Crimpgröße 2 (0,08 - 0,20 mm²)
7000 Stück auf Rolle
crimping size 2 (0.08 - 0.20 mm²)
7000 pcs on reel
61.171.80



Ø 1 mm
Crimpgröße 3 (0,20 - 0,52 mm²)
7000 Stück auf Rolle
crimping size 3 (0.20 - 0.52 mm²)
7000 pcs on reel
61.172.80



Ø 1 mm
Crimpgröße 4 (0,75 - 1,0 mm²)
10 000 Stück auf Rolle
crimping size 4 (0.75 - 1.0 mm²)
10000 pcs on reel
61.173.80

Art.-Nr. Art. No.

Isolierkörper und Kontakte Insulation Inserts and Contacts

151

6-polig P 6-pin P
(6 x Ø 2 mm)

0° codiert 0° coded

Ansicht steckseitig mating view



152

6-polig E 6-pin E
(6 x Ø 2 mm)

0° codiert 0° coded

Ansicht steckseitig mating view

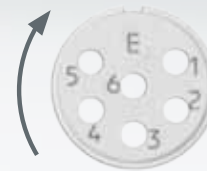

157

7-polig P 7-pin P
(7 x Ø 2 mm)

0° codiert 0° coded

Ansicht steckseitig mating view



158

7-polig E 7-pin E
(7 x Ø 2 mm)

0° codiert 0° coded

Ansicht steckseitig mating view

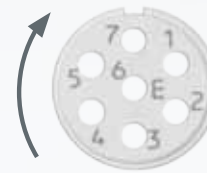

NN 00

Kontaktbuchse Ø 2 mm Contact Socket Ø 2 mm
Nicht im Lieferumfang enthalten Not part of product contents



Ø 2 mm
geschlitzt, Crimpbereich 0,35 - 2,5 mm²
slotted, crimping range 0.35 - 2.5 mm²
60.012.11



Ø 2 mm
geschlitzt, Lötkehl 2,5 mm²
slotted, solder bucket 2.5 mm²
60.014.11

NN 00

Kontaktstift Ø 2 mm Contact Pin Ø 2 mm
Nicht im Lieferumfang enthalten Not part of product contents



Ø 2 mm
Crimpereich 0,35 - 2,5 mm²
crimping range 0.35 - 2.5 mm²
61.008.11



Ø 2 mm
Lötkehl 2,5 mm²
solder bucket 2.5 mm²
61.011.11

Art-Nr. Art. No.

055

9-polig P 9-pin P
(9 x Ø 1 mm)

uncodiert uncodet

Ansicht steckseitig mating view

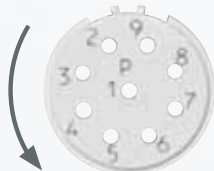

054

9-polig E 9-pin E
(9 x Ø 1 mm)

uncodiert uncodet

Ansicht steckseitig mating view

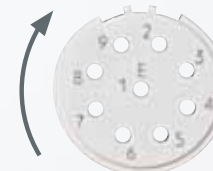

NN 00

Kontaktbuchse Ø 1 mm Contact Socket Ø 1 mm
Nicht im Lieferumfang enthalten Not part of product contents



Ø 1 mm
Drahtfeder, Crimpbereich 0,14 - 1,0 mm²
wire spring, crimping range 0.14 - 1.0 mm²
60.001.11



Ø 1 mm
geschlitzt, Crimpbereich 0,14 - 1,0 mm²
slotted, crimping range 0.14 - 1.0 mm²
60.011.11



Ø 1 mm
Drahtfeder, Lötkehl 1,5 mm²
wire spring, solder bucket 1.5 mm²
60.004.11



Ø 1 mm
geschlitzt, Lötkehl 1,5 mm²
slotted, solder bucket 1.5 mm²
60.013.11



Ø 1 mm
geschlitzt, Crimpbereich 0,03 - 0,34 mm²
slotted, crimping range 0.03 - 0.34 mm²
60.172.11

Art-Nr. Art. No.

NN 00

Kontaktstift Ø 1 mm Contact Pin Ø 1 mm
Nicht im Lieferumfang enthalten Not part of product contents



Ø 1 mm
Crimpereich 0,14 - 1,0 mm²
crimping range 0.14 - 1.0 mm²
61.004.11



Ø 1 mm
Lötkehl 1,5 mm²
solder bucket 1.5 mm²
61.006.11



Ø 1 mm
Crimpereich 0,03 - 0,34 mm²
crimping range 0.03 - 0.34 mm²
61.083.11

Art-Nr. Art. No.

Isolierkörper und Kontakte

Insulation Inserts and Contacts

070

8+1-polig P 8+1-pin P
(8 x Ø 1 mm + 1 x Ø 2 mm)

uncodiert uncodet

Ansicht steckseitig mating view



071

8+1-polig E 8+1-pin E
(8 x Ø 1 mm + 1 x Ø 2 mm)

uncodiert uncodet

Ansicht steckseitig mating view

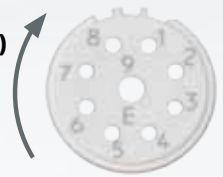

NN 00

Kontaktbuchse Ø 1 mm Contact Socket Ø 1 mm
Nicht im Lieferumfang enthalten Not part of product contents



Ø 1 mm
Drahtfeder, Crimpbereich 0,14 - 1,0 mm²
wire spring, crimping range 0.14 - 1.0 mm²

60.001.11



Ø 1 mm
geschlitzt, Crimpbereich 0,14 - 1,0 mm²
slotted, crimping range 0.14 - 1.0 mm²

60.011.11



Ø 1 mm
Drahtfeder, Lötkehl 1,5 mm²
wire spring, solder bucket 1.5 mm²

60.004.11



Ø 1 mm
geschlitzt, Lötkehl 1,5 mm²
slotted, solder bucket 1.5 mm²

60.013.11



Ø 1 mm
geschlitzt, Crimpbereich 0,03 - 0,34 mm²
slotted, crimping range 0.03 - 0.34 mm²

60.172.11

NN 00

Kontaktbuchse Ø 2 mm Contact Socket Ø 2 mm
Nicht im Lieferumfang enthalten Not part of product contents



Ø 2 mm
geschlitzt, Crimpbereich 0,35 - 2,5 mm²
slotted, crimping range 0.35 - 2.5 mm²

60.012.11



Ø 2 mm
geschlitzt, Lötkehl 2,5 mm²
slotted, solder bucket 2.5 mm²

60.014.11

NN 00

Kontaktstift Ø 1 mm Contact Pin Ø 1 mm
Nicht im Lieferumfang enthalten Not part of product contents



Ø 1 mm
Crimpbereich 0,14 - 1,0 mm²
crimping range 0.14 - 1.0 mm²

61.004.11



Ø 1 mm
Lötkehl 1,5 mm²
solder bucket 1.5 mm²

61.006.11



Ø 1 mm
Crimpbereich 0,03 - 0,34 mm²
crimping range 0.03 - 0.34 mm²

61.083.11



Ø 2 mm
Crimpbereich 0,35 - 2,5 mm²
crimping range 0.35 - 2.5 mm²

61.008.11



Ø 2 mm
Lötkehl 2,5 mm²
solder bucket 2.5 mm²

61.011.11

Insulation Inserts and Contacts



12-polig P 12-pin P (12 x Ø 1 mm)

0° codiert 0° coded

Ansicht steckseitig mating view



12-polig E 12-pin E (12 x Ø 1 mm)

0° codiert 0° coded

Ansicht steckseitig mating view

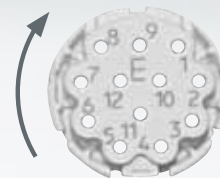

17-polig P 17-pin P (17 x Ø 1 mm)

0° codiert 0° coded

Ansicht steckseitig mating view

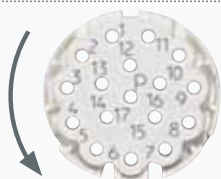

17-polig E 17-pin E (17 x Ø 1 mm)

0° codiert 0° coded

Ansicht steckseitig mating view

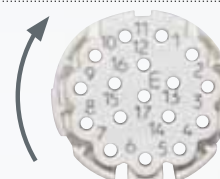

Kontaktbuchse Ø 1 mm Contact Socket Ø 1 mm Nicht im Lieferumfang enthalten Not part of product contents



Ø 1 mm
Drahtfeder, Crimpbereich 0,14 - 1,0 mm²
wire spring, crimping range 0,14 - 1,0 mm²
60.001.11



Ø 1 mm
geschlitzt, Crimpbereich 0,14 - 1,0 mm²
slotted, crimping range 0,14 - 1,0 mm²
60.011.11



Ø 1 mm
Drahtfeder, Lötkelch 1,5 mm²
wire spring, solder bucket 1,5 mm²
60.004.11



Ø 1 mm
geschlitzt, Lötkelch 1,5 mm²
slotted, solder bucket 1,5 mm²
60.013.11



Ø 1 mm
geschlitzt, Crimpbereich 0,03 - 0,34 mm²
slotted, crimping range 0,03 - 0,34 mm²
60.172.11

Art.-Nr. Art. No.



Kontaktstift Ø 1 mm Contact Pin Ø 1 mm Nicht im Lieferumfang enthalten Not part of product contents



Ø 1 mm
Crimpbereich 0,14 - 1,0 mm²
crimping range 0,14 - 1,0 mm²
61.004.11



Ø 1 mm
Lötkelch 1,5 mm²
solder bucket 1,5 mm²
61.006.11



Ø 1 mm
Crimpbereich 0,03 - 0,34 mm²
crimping range 0,03 - 0,34 mm²
61.083.11

Art.-Nr. Art. No.



Bandkontaktbuchse Ø 1 mm Bandoleer Contact Socket Ø 1 mm Nicht im Lieferumfang enthalten Not part of product contents



Ø 1 mm
Crimprgröße 1 (0,03 - 0,08 mm²)
7000 Stück auf Rolle
crimping size 1 (0,03 - 0,08 mm²)
7000 pcs on reel
60.198.80



Ø 1 mm
Crimprgröße 2 (0,08 - 0,20 mm²)
7000 Stück auf Rolle
crimping size 2 (0,08 - 0,20 mm²)
7000 pcs on reel
60.199.80



Ø 1 mm
Crimprgröße 3 (0,20 - 0,52 mm²)
7000 Stück auf Rolle
crimping size 3 (0,20 - 0,52 mm²)
7000 pcs on reel
60.200.80



Ø 1 mm
Crimprgröße 4 (0,75 - 1,0 mm²)
10000 Stück auf Rolle
crimping size 4 (0,75 - 1,0 mm²)
10000 pcs on reel
60.201.80

Art.-Nr. Art. No.



Bandkontaktstift Ø 1 mm Bandoleer Contact Pin Ø 1 mm Nicht im Lieferumfang enthalten Not part of product contents



Ø 1 mm
Crimprgröße 1 (0,03 - 0,08 mm²)
7000 Stück auf Rolle
crimping size 1 (0,03 - 0,08 mm²)
7000 pcs on reel
61.170.80

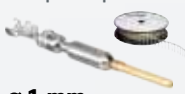

Ø 1 mm
Crimprgröße 2 (0,08 - 0,20 mm²)
7000 Stück auf Rolle
crimping size 2 (0,08 - 0,20 mm²)
7000 pcs on reel
61.171.80



Ø 1 mm
Crimprgröße 3 (0,20 - 0,52 mm²)
7000 Stück auf Rolle
crimping size 3 (0,20 - 0,52 mm²)
7000 pcs on reel
61.172.80



Ø 1 mm
Crimprgröße 4 (0,75 - 1,0 mm²)
10000 Stück auf Rolle
crimping size 4 (0,75 - 1,0 mm²)
10000 pcs on reel
61.173.80

Art.-Nr. Art. No.

Isolierkörper und Kontakte Insulation Inserts and Contacts

558

16+3-polig P 16+3-pin P (16 x Ø 1 mm + 3 x Ø 1,5 mm)

0° codiert 0° coded

Ansicht steckseitig mating view



559

16+3-polig E 16+3-pin E (16 x Ø 1 mm + 3 x Ø 1,5 mm)

0° codiert 0° coded

Ansicht steckseitig mating view

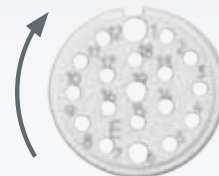

NN 00

Kontaktbuchse Ø 1 mm Contact Socket Ø 1 mm Nicht im Lieferumfang enthalten Not part of product contents



Ø 1 mm

Drahtfeder, Crimpbereich 0,14 - 1,0 mm²
wire spring, crimping range 0.14 - 1.0 mm²

Art.-Nr. Art. No. 60.001.11



Ø 1 mm

geschlitzt, Crimpbereich 0,14 - 1,0 mm²
slotted, crimping range 0.14 - 1.0 mm²

60.011.11



Ø 1 mm

Drahtfeder, Lötkelch 1,5 mm²
wire spring, solder bucket 1.5 mm²

60.004.11



Ø 1 mm

geschlitzt, Lötkelch 1,5 mm²
slotted, solder bucket 1.5 mm²

60.013.11



Ø 1 mm

geschlitzt, Crimpbereich 0,03 - 0,34 mm²
slotted, crimping range 0.03 - 0.34 mm²

60.172.11

NN 00

Kontaktbuchse Ø 1,5 mm Contact Socket Ø 1,5 mm Nicht im Lieferumfang enthalten Not part of product contents



Ø 1,5 mm

geschlitzt, Crimpbereich 0,24 - 1,0 mm²
slotted, crimping range 0.24 - 1.0 mm²

Art.-Nr. Art. No. 60.070.11



Ø 1,5 mm

geschlitzt, Lötkelch 1,5 mm²
slotted, solder bucket 1.5 mm²

60.173.11

NN 00

Kontaktstift Ø 1 mm Contact Pin Ø 1 mm Nicht im Lieferumfang enthalten Not part of product contents



Ø 1 mm

Crimpereich 0,14 - 1,0 mm²
crimping range 0.14 - 1.0 mm²

Art.-Nr. Art. No. 61.004.11



Ø 1 mm

Lötkelch 1,5 mm²
solder bucket 1.5 mm²

61.006.11



Ø 1 mm

Crimpereich 0,03 - 0,34 mm²
crimping range 0.03 - 0.34 mm²

61.083.11



Ø 1,5 mm

Crimpereich 0,24 - 1,0 mm²
crimping range 0.24 - 1.0 mm²

61.072.11



Ø 1,5 mm

Lötkelch 1,5 mm²
solder bucket 1.5 mm²

61.152.11

NN 00

Bandkontaktbuchse Ø 1 mm Bandoleer Contact Socket Ø 1 mm Nicht im Lieferumfang enthalten Not part of product contents



Ø 1 mm

Crimpgröße 1 (0,03 - 0,08 mm²)
7000 Stück auf Rolle
crimping size 1 (0.03 - 0.08 mm²)
7000 pcs on reel

Art.-Nr. Art. No. 60.198.80



Ø 1 mm

Crimpgröße 2 (0,08 - 0,20 mm²)
7000 Stück auf Rolle
crimping size 2 (0.08 - 0.20 mm²)
7000 pcs on reel

60.199.80



Ø 1 mm

Crimpgröße 3 (0,20 - 0,52 mm²)
7000 Stück auf Rolle
crimping size 3 (0.20 - 0.52 mm²)
7000 pcs on reel

60.200.80



Ø 1 mm

Crimpgröße 4 (0,75 - 1,0 mm²)
10000 Stück auf Rolle
crimping size 4 (0.75 - 1.0 mm²)
10000 pcs on reel

60.201.80

NN 00

Bandkontaktstift Ø 1 mm Bandoleer Contact Pin Ø 1 mm Nicht im Lieferumfang enthalten Not part of product contents



Ø 1 mm

Crimpgröße 1 (0,03 - 0,08 mm²)
7000 Stück auf Rolle
crimping size 1 (0.03 - 0.08 mm²)
7000 pcs on reel

Art.-Nr. Art. No. 61.170.80



Ø 1 mm

Crimpgröße 2 (0,08 - 0,20 mm²)
7000 Stück auf Rolle
crimping size 2 (0.08 - 0.20 mm²)
7000 pcs on reel

61.171.80



Ø 1 mm

Crimpgröße 3 (0,20 - 0,52 mm²)
7000 Stück auf Rolle
crimping size 3 (0.20 - 0.52 mm²)
7000 pcs on reel

61.172.80



Ø 1 mm

Crimpgröße 4 (0,75 - 1,0 mm²)
10000 Stück auf Rolle
crimping size 4 (0.75 - 1.0 mm²)
10000 pcs on reel

61.173.80

Kabelklemmungen Cable Clamps



Kronenklemmung Crown Clamp

Kabelklemmbereich 4,2 - 6,6 mm cable clamping range 4.2 - 6.6 mm

Integrierte Dichtung, Verdrehsicherung und koaxiale Kronen-Schirmanbindung.
Keine Schirmkürzung erforderlich. Integrated seal, anti-twist protection and coaxial crown shield connection. No shield trimming required.

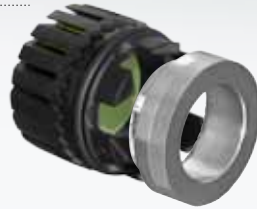

Kabelklemmbereich 7,5 - 12,0 mm cable clamping range 7.5 - 12.0 mm



Kabelklemmbereich 9,5 - 14,5 mm cable clamping range 9.5 - 14.5 mm



Lamellenklemmung Lamella Clamp

Kabelklemmbereich 4,2 - 6,6 mm cable clamping range 4.2 - 6.6 mm

Integrierte Dichtung, Verdrehsicherung und koaxiale Schirmanbindung
Integrated seal, anti-twist protection and coaxial shield connection



Kabelklemmbereich 7,5 - 12,0 mm cable clamping range 7.5 - 12.0 mm



Kabelklemmbereich 9,5 - 14,5 mm cable clamping range 9.5 - 14.5 mm



Kabelklemmbereich 14,0 - 17,0 mm cable clamping range 14.0 - 17.0 mm



Knopfklammer Ball Clamp

Kabelklemmbereich 9,0 - 14,0 mm cable clamping range 9.0 - 14.0 mm

Integrierte 2-Lippen-Dichtung und koaxiale Schirmanbindung.
Integrated double lip seal and coaxial shield connection.





A E G ■ ■ ■ ■ ■ ■ ■ ■ ■ ■ 00 0201 ■ ■ ■ ■

A vernickelt nickel-plated

Einbaudose Receptacle

mit Aussengewinde M23 x 1 und Vibrationsschutz-O-Ring, speedtec-ready, Flanschbefestigung 25 x 25 mm, axiale O-Ring-Abdichtung
with outside thread M23 x 1 and anti-vibration o-ring, speedtec-ready, flange mount 25 x 25 mm, axial o-ring seal

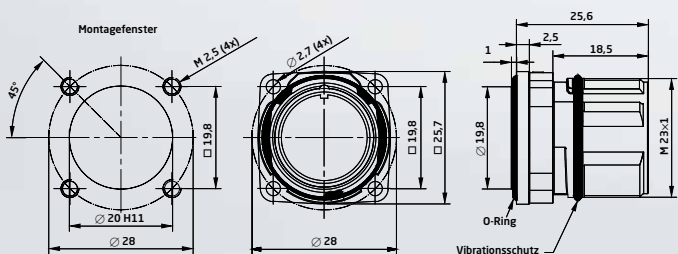

A E G ■ ■ ■ ■ ■ ■ ■ ■ ■ ■ 00 0101 ■ ■ ■ ■

A vernickelt nickel-plated

Einbaudose Receptacle

für speedtec Schnellverschluss, Flanschbefestigung 25 x 25 mm, axiale O-Ring-Abdichtung
for speedtec quick lock fastener, flange mount 25 x 25 mm, axial o-ring seal

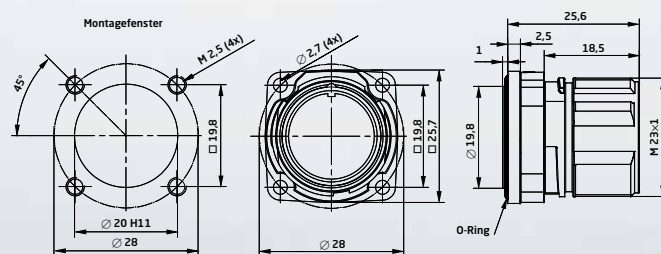

A E G ■ ■ ■ ■ ■ ■ ■ ■ ■ ■ 00 0203 ■ ■ ■ ■

A vernickelt nickel-plated

Einbaudose Receptacle

mit Aussengewinde M23 x 1 und Vibrationsschutz-O-Ring, speedtec-ready, Montagegewinde M20 x 1,5, axiale O-Ring-Abdichtung
with outside thread M23 x 1 and anti-vibration o-ring, speedtec-ready, mounting side threaded M20 x 1,5, axial o-ring seal

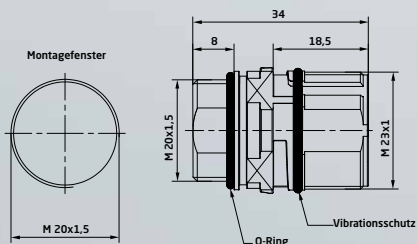

A E G ■ ■ ■ ■ ■ ■ ■ ■ ■ ■ 00 0103 ■ ■ ■ ■

A vernickelt nickel-plated

Einbaudose Receptacle

für speedtec Schnellverschluss, Montagegewinde M20 x 1,5, axiale O-Ring-Abdichtung
for speedtec quick lock fastener, mounting side threaded M20 x 1,5, axial o-ring seal

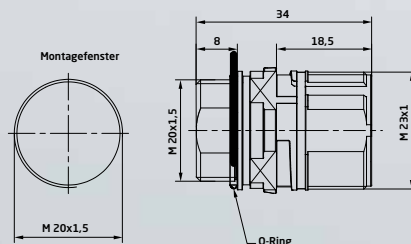



A E G ■ ■ ■ ■ ■ ■ ■ ■ ■ ■ 00 0200 ■ ■ ■ ■

A vernickelt nickel-plated

Einbaudose Receptacle

mit Aussengewinde M23 x 1 und Vibrationsschutz-O-Ring, speedtec-ready, Flanschbefestigung 28 x 28 mm, axiale O-Ring-Abdichtung
with outside thread M23 x 1 and anti-vibration o-ring, speedtec-ready, flange mount 28 x 28 mm, axial o-ring seal

A E G ■ ■ ■ ■ ■ ■ ■ ■ ■ ■ 00 0100 ■ ■ ■ ■

A vernickelt nickel-plated

Einbaudose Receptacle

für speedtec Schnellverschluss, Flanschbefestigung 28 x 28 mm, axiale O-Ring-Abdichtung
for speedtec quick lock fastener, flange mount 28 x 28 mm, axial o-ring seal

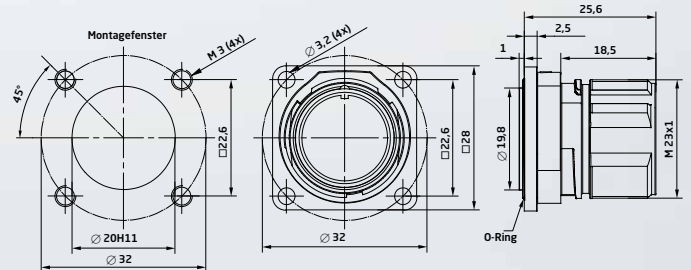
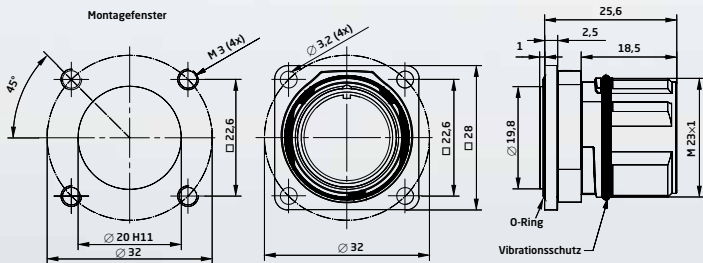

A E G ■ ■ ■ ■ ■ ■ ■ ■ ■ ■ 00 0204 ■ ■ ■ ■

A vernickelt nickel-plated

Einbaudose Receptacle

mit Aussengewinde M23 x 1 und Vibrationsschutz-O-Ring, speedtec-ready, Montagegewinde M20 x 1,5 mit Feststellring, axiale O-Ring-Abdichtung
with outside thread M23 x 1 and anti-vibration o-ring, speedtec-ready, mounting thread M20 x 1.5 with retaining ring, axial o-ring seal

A E G ■ ■ ■ ■ ■ ■ ■ ■ ■ ■ 00 0104 ■ ■ ■ ■

A vernickelt nickel-plated

Einbaudose Receptacle

für speedtec Schnellverschluss, Montagegewinde M20 x 1,5 mit Feststellring, axiale O-Ring-Abdichtung
for speedtec quick lock fastener, mounting thread M20 x 1.5 with retaining ring, axial o-ring seal

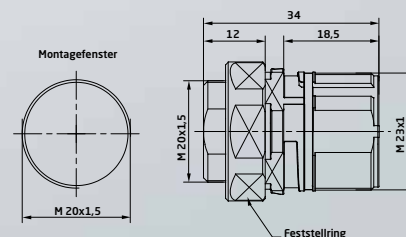
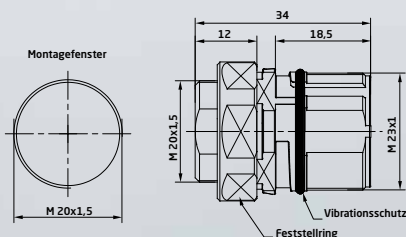



A E G ■ ■ ■ ■ ■ ■ ■ ■ ■ ■ 00 0236 ■ ■ ■ ■

A vernickelt nickel-plated

Einbaudose Receptacle

mit Aussengewinde M23 x 1 und Vibrationsschutz-O-Ring, speedtec-ready, Montagegewinde M20 x 1,5 mit Kontermutter, axiale O-Ring-Abdichtung

with outside thread M23 x 1 and anti-vibration o-ring, speedtec-ready, mounting side threaded M20 x 1.5 with lock nut, axial o-ring seal

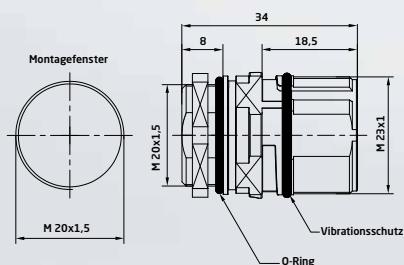

A E G ■ ■ ■ ■ ■ ■ ■ ■ ■ ■ 00 0136 ■ ■ ■ ■

A vernickelt nickel-plated

Einbaudose Receptacle

für speedtec Schnellverschluss, Montagegewinde M20 x 1,5 mit Kontermutter, axiale O-Ring-Abdichtung

for speedtec quick lock fastener, mounting side threaded M20 x 1.5 with lock nut, axial o-ring seal

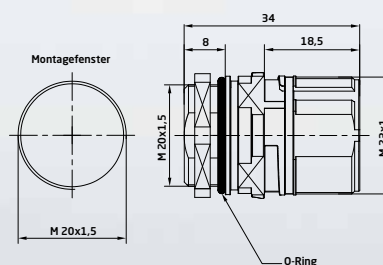

Isolierkörper wie Kupplung S.45-48
Insulation like Receptacle p. 45-48



A E G ■ ■ ■ ■ ■ ■ ■ ■ ■ ■ 00 0202 ■ ■ ■ ■

A vernickelt nickel-plated

Einbaudose Receptacle

mit Aussengewinde M23 x 1 und Vibrationsschutz-O-Ring, speedtec-ready, Hinterwandmontage mit Kontermutter M25 x 1,5, axiale O-Ring-Abdichtung, Wanddicken bis 7,5 mm

with outside thread M23 x 1 and anti-vibration o-ring, speedtec-ready, rear mount with lock nut M25 x 1.5, axial o-ring seal, wall thickness 7.5 max

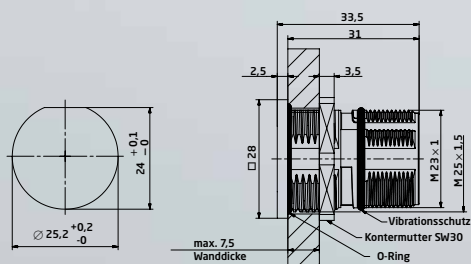

A E G ■ ■ ■ ■ ■ ■ ■ ■ ■ ■ 00 0102 ■ ■ ■ ■

A vernickelt nickel-plated

Einbaudose Receptacle

für speedtec Schnellverschluss, Hinterwandmontage mit Kontermutter M25 x 1,5, axiale O-Ring-Abdichtung, Wanddicken bis 7,5 mm

for speedtec quick lock fastener, rear mount with lock nut M25 x 1.5, axial o-ring seal, wall thickness 7.5 max

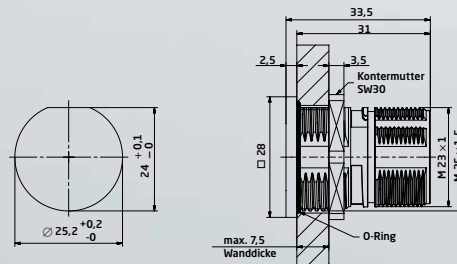

Isolierkörper und Kontakte Insulation Inserts and Contacts



6-polig P 6-pin P
(6 x Ø 2 mm)

0° codiert, mit Sprengring
0° coded with retention ring

Ansicht steckseitig mating view

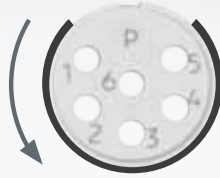

6-polig E 6-pin E
(6 x Ø 2 mm)

0° codiert, mit Sprengring
0° coded with retention ring

Ansicht steckseitig mating view

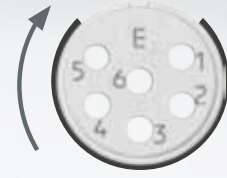

7-polig P 7-pin P
(7 x Ø 2 mm)

0° codiert, mit Sprengring
0° coded with retention ring

Ansicht steckseitig mating view

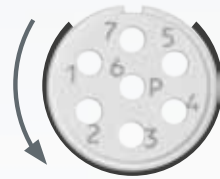

7-polig E 7-pin E
(7 x Ø 2 mm)

0° codiert, mit Sprengring
0° coded with retention ring

Ansicht steckseitig mating view

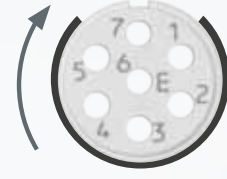

Kontaktbuchse Ø 2 mm Contact Socket Ø 2 mm
Nicht im Lieferumfang enthalten Not part of product contents



Ø 2 mm
geschlitzt, Crimpbereich 0,35 - 2,5 mm²
slotted, crimping range 0.35 - 2.5 mm²
60.012.11



Ø 2 mm
geschlitzt, Lötkelch 2,5 mm²
slotted, solder bucket 2.5 mm²
60.014.11



Kontaktstift Ø 2 mm Contact Pin Ø 2 mm
Nicht im Lieferumfang enthalten Not part of product contents



Ø 2 mm
Crimpbereich 0,35 - 2,5 mm²
crimping range 0.35 - 2.5 mm²
61.008.11



Ø 2 mm
Lötkelch 2,5 mm²
solder bucket 2.5 mm²
61.011.11

Art-Nr. Art. No.

Art-Nr. Art. No.

Isolierkörper und Kontakte



8+1-polig P 8+1-pin P (8 x Ø 1 mm + 1 x Ø 2 mm)

uncodiert, mit Sprengring
uncoded with retention ring

Ansicht steckseitig mating view



8+1-polig E 8+1-pin E (8 x Ø 1 mm + 1 x Ø 2 mm)

uncodiert, mit Sprengring
uncoded with retention ring

Ansicht steckseitig mating view



Kontaktbuchse Ø 1 mm Contact Socket Ø 1 mm Nicht im Lieferumfang enthalten Not part of product contents



Ø 1 mm

Drahtfeder, Crimpbereich 0,14 - 1,0 mm²
wire spring, crimping range 0.14 - 1.0 mm²

Art.-Nr. Art. No. 60.001.11



Ø 1 mm

geschlitzt, Crimpbereich 0,14 - 1,0 mm²
slotted, crimping range 0.14 - 1.0 mm²

60.011.11



Ø 1 mm

Drahtfeder, Lötkeilch 1,5 mm²
wire spring, solder bucket 1.5 mm²

60.004.11



Ø 1 mm

geschlitzt, Lötkeilch 1,5 mm²
slotted, solder bucket 1.5 mm²

60.013.11



Ø 1 mm

geschlitzt, Crimpbereich 0,03 - 0,34 mm²
slotted, crimping range 0.03 - 0.34 mm²

60.172.11



Kontaktbuchse Ø 2 mm Contact Socket Ø 2 mm Nicht im Lieferumfang enthalten Not part of product contents



Ø 2 mm

geschlitzt, Crimpbereich 0,35 - 2,5 mm²
slotted, crimping range 0.35 - 2.5 mm²

Art.-Nr. Art. No. 60.012.11



Ø 2 mm

geschlitzt, Lötkeilch 2,5 mm²
slotted, solder bucket 2.5 mm²

60.014.11



Kontaktstift Ø 1 mm Contact Pin Ø 1 mm Nicht im Lieferumfang enthalten Not part of product contents



Ø 1 mm

Crimpbereich 0,14 - 1,0 mm²
crimping range 0.14 - 1.0 mm²

Art.-Nr. Art. No. 61.004.11



Ø 1 mm

Lötkeilch 1,5 mm²
solder bucket 1.5 mm²

61.006.11



Ø 1 mm

Crimpbereich 0,03 - 0,34 mm²
crimping range 0.03 - 0.34 mm²

61.083.11



Kontaktstift Ø 2 mm Contact Pin Ø 2 mm Nicht im Lieferumfang enthalten Not part of product contents



Ø 2 mm

Crimpbereich 0,35 - 2,5 mm²
crimping range 0.35 - 2.5 mm²

Art.-Nr. Art. No. 61.008.11



Ø 2 mm

Lötkeilch 2,5 mm²
solder bucket 2.5 mm²

61.011.11

Insulation Inserts and Contacts



9-polig P 9-pin P (9 x Ø 1 mm)

uncodiert, mit Sprengring
uncoded with retention ring

Ansicht steckseitig mating view

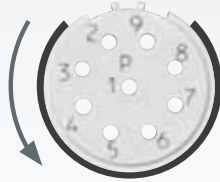

9-polig E 9-pin E (9 x Ø 1 mm)

uncodiert, mit Sprengring
uncoded with retention ring

Ansicht steckseitig mating view

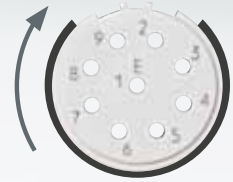

Kontaktbuchse Ø 1 mm Contact Socket Ø 1 mm Nicht im Lieferumfang enthalten Not part of product contents



Ø 1 mm

Drahtfeder, Crimpbereich 0,14 - 1,0 mm²
wire spring, crimping range 0,14 - 1,0 mm²

60.001.11



Ø 1 mm

geschlitzt, Crimpbereich 0,14 - 1,0 mm²
slotted, crimping range 0,14 - 1,0 mm²

60.011.11



Ø 1 mm

Drahtfeder, Lötkehlch 1,5 mm²
wire spring, solder bucket 1,5 mm²

60.004.11



Ø 1 mm

geschlitzt, Lötkehlch 1,5 mm²
slotted, solder bucket 1,5 mm²

60.013.11



Ø 1 mm

geschlitzt, Crimpbereich 0,03 - 0,34 mm²
slotted, crimping range 0,03 - 0,34 mm²

60.172.11

Art.-Nr. Art. No.



Kontaktstift Ø 1 mm Contact Pin Ø 1 mm Nicht im Lieferumfang enthalten Not part of product contents



Ø 1 mm

Crimpereich 0,14 - 1,0 mm²
crimping range 0,14 - 1,0 mm²

61.004.11



Ø 1 mm

Lötkehlch 1,5 mm²
solder bucket 1,5 mm²

61.006.11



Ø 1 mm

Crimpereich 0,03 - 0,34 mm²
crimping range 0,03 - 0,34 mm²

61.083.11

Art.-Nr. Art. No.

Isolierkörper und Kontakte



12-polig P 12-pin P (12 x Ø 1 mm)

0° codiert 0° coded

Ansicht steckseitig mating view



12-polig E 12-pin E (12 x Ø 1 mm)

0° codiert 0° coded

Ansicht steckseitig mating view

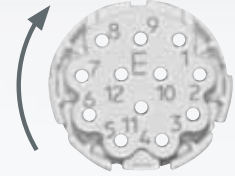

17-polig P 17-pin P (17 x Ø 1 mm)

0° codiert 0° coded

Ansicht steckseitig mating view

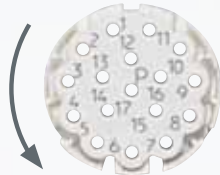

17-polig E 17-pin E (17 x Ø 1 mm)

0° codiert 0° coded

Ansicht steckseitig mating view

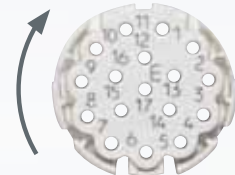

Kontaktbuchse Ø 1 mm Contact Socket Ø 1 mm Nicht im Lieferumfang enthalten Not part of product contents



Ø 1 mm
Drahtfeder, Crimpbereich 0,14 - 1,0 mm²
wire spring, crimping range 0.14 - 1.0 mm²
60.001.11



Ø 1 mm
geschlitzt, Crimpbereich 0,14 - 1,0 mm²
slotted, crimping range 0.14 - 1.0 mm²
60.011.11



Ø 1 mm
Drahtfeder, Lötkelch 1,5 mm²
wire spring, solder bucket 1.5 mm²
60.004.11



Ø 1 mm
geschlitzt, Lötkelch 1,5 mm²
slotted, solder bucket 1.5 mm²
60.013.11



Ø 1 mm
geschlitzt, Crimpbereich 0,03 - 0,34 mm²
slotted, crimping range 0.03 - 0.34 mm²
60.172.11

Art.-Nr. Art. No.



Kontaktstift Ø 1 mm Contact Pin Ø 1 mm Nicht im Lieferumfang enthalten Not part of product contents



Ø 1 mm
Crimpbereich 0,14 - 1,0 mm²
crimping range 0.14 - 1.0 mm²
61.004.11



Ø 1 mm
Lötkelch 1,5 mm²
solder bucket 1.5 mm²
61.006.11



Ø 1 mm
Crimpbereich 0,03 - 0,34 mm²
crimping range 0.03 - 0.34 mm²
61.083.11

Art.-Nr. Art. No.



Bandkontaktbuchse Ø 1 mm Bandoleer Contact Socket Ø 1 mm Nicht im Lieferumfang enthalten Not part of product contents



Ø 1 mm
Crimprgröße 1 (0,03 - 0,08 mm²)
7000 Stück auf Rolle
crimping size 1 (0.03 - 0.08 mm²)
7000 pcs on reel
60.198.80



Ø 1 mm
Crimprgröße 2 (0,08 - 0,20 mm²)
7000 Stück auf Rolle
crimping size 2 (0.08 - 0.20 mm²)
7000 pcs on reel
60.199.80



Ø 1 mm
Crimprgröße 3 (0,20 - 0,52 mm²)
7000 Stück auf Rolle
crimping size 3 (0.20 - 0.52 mm²)
7000 pcs on reel
60.200.80



Ø 1 mm
Crimprgröße 4 (0,75 - 1,0 mm²)
10000 Stück auf Rolle
crimping size 4 (0.75 - 1.0 mm²)
10000 pcs on reel
60.201.80

Art.-Nr. Art. No.



Bandkontaktstift Ø 1 mm Bandoleer Contact Pin Ø 1 mm Nicht im Lieferumfang enthalten Not part of product contents



Ø 1 mm
Crimprgröße 1 (0,03 - 0,08 mm²)
7000 Stück auf Rolle
crimping size 1 (0.03 - 0.08 mm²)
7000 pcs on reel
61.170.80



Ø 1 mm
Crimprgröße 2 (0,08 - 0,20 mm²)
7000 Stück auf Rolle
crimping size 2 (0.08 - 0.20 mm²)
7000 pcs on reel
61.171.80



Ø 1 mm
Crimprgröße 3 (0,20 - 0,52 mm²)
7000 Stück auf Rolle
crimping size 3 (0.20 - 0.52 mm²)
7000 pcs on reel
61.172.80



Ø 1 mm
Crimprgröße 4 (0,75 - 1,0 mm²)
10000 Stück auf Rolle
crimping size 4 (0.75 - 1.0 mm²)
10000 pcs on reel
61.173.80

Art.-Nr. Art. No.

Insulation Inserts and Contacts



16+3-polig P 16+3-pin P (16 x Ø 1 mm + 3 x Ø 1,5 mm)

0° codiert, mit Sprengring
0° coded with retention ring

Ansicht steckseitig mating view

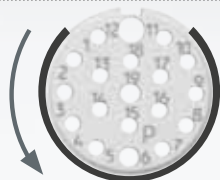

16+3-polig E 16+3-pin E (16 x Ø 1 mm + 3 x Ø 1,5 mm)

0° codiert, mit Sprengring
0° coded with retention ring

Ansicht steckseitig mating view

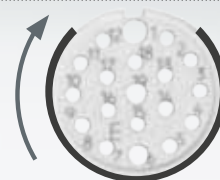

Kontaktbuchse Ø 1 mm Contact Socket Ø 1 mm Nicht im Lieferumfang enthalten Not part of product contents



Ø 1 mm
Drahtfeder, Crimpbereich 0,14 - 1,0 mm²
wire spring, crimping range 0.14 - 1.0 mm²
60.001.11



Ø 1 mm
geschlitzt, Crimpbereich 0,14 - 1,0 mm²
slotted, crimping range 0.14 - 1.0 mm²
60.011.11



Ø 1 mm
Drahtfeder, Lötkehl 1,5 mm²
wire spring, solder bucket 1.5 mm²
60.004.11



Ø 1 mm
geschlitzt, Lötkehl 1,5 mm²
slotted, solder bucket 1.5 mm²
60.013.11



Ø 1 mm
geschlitzt, Crimpbereich 0,03 - 0,34 mm²
slotted, crimping range 0.03 - 0.34 mm²
60.172.11

Art.-Nr. Art. No.



Kontaktbuchse Ø 1,5 mm Contact Socket Ø 1,5 mm Nicht im Lieferumfang enthalten Not part of product contents



Ø 1,5 mm
geschlitzt, Crimpbereich 0,24 - 1,0 mm²
slotted, crimping range 0.24 - 1.0 mm²
60.070.11



Ø 1,5 mm
geschlitzt, Lötkehl 1,5 mm²
slotted, solder bucket 1.5 mm²
60.173.11

Art.-Nr. Art. No.



Kontaktstift Ø 1 mm Contact Pin Ø 1 mm Nicht im Lieferumfang enthalten Not part of product contents



Ø 1 mm
Crimpereich 0,14 - 1,0 mm²
crimping range 0.14 - 1.0 mm²
61.004.11



Ø 1 mm
Lötkehl 1,5 mm²
solder bucket 1.5 mm²
61.006.11



Ø 1 mm
Crimpereich 0,03 - 0,34 mm²
crimping range 0.03 - 0.34 mm²
61.083.11



Ø 1,5 mm
Crimpereich 0,24 - 1,0 mm²
crimping range 0.24 - 1.0 mm²
61.072.11



Ø 1,5 mm
Lötkehl 1,5 mm²
solder bucket 1.5 mm²
61.152.11

Art.-Nr. Art. No.



Bandkontaktbuchse Ø 1 mm Bandoleer Contact Socket Ø 1 mm Nicht im Lieferumfang enthalten Not part of product contents



Ø 1 mm
Crimpgröße 1 (0,03 - 0,08 mm²)
7000 Stück auf Rolle
crimping size 1 (0.03 - 0.08 mm²)
7000 pcs on reel
60.198.80



Ø 1 mm
Crimpgröße 2 (0,08 - 0,20 mm²)
7000 Stück auf Rolle
crimping size 2 (0.08 - 0.20 mm²)
7000 pcs on reel
60.199.80



Ø 1 mm
Crimpgröße 3 (0,20 - 0,52 mm²)
7000 Stück auf Rolle
crimping size 3 (0.20 - 0.52 mm²)
7000 pcs on reel
60.200.80



Ø 1 mm
Crimpgröße 4 (0,75 - 1,0 mm²)
10 000 Stück auf Rolle
crimping size 4 (0.75 - 1.0 mm²)
10000 pcs on reel
60.201.80

Art.-Nr. Art. No.



Bandkontaktstift Ø 1 mm Bandoleer Contact Pin Ø 1 mm Nicht im Lieferumfang enthalten Not part of product contents



Ø 1 mm
Crimpgröße 1 (0,03 - 0,08 mm²)
7000 Stück auf Rolle
crimping size 1 (0.03 - 0.08 mm²)
7000 pcs on reel
61.170.80



Ø 1 mm
Crimpgröße 2 (0,08 - 0,20 mm²)
7000 Stück auf Rolle
crimping size 2 (0.08 - 0.20 mm²)
7000 pcs on reel
61.171.80



Ø 1 mm
Crimpgröße 3 (0,20 - 0,52 mm²)
7000 Stück auf Rolle
crimping size 3 (0.20 - 0.52 mm²)
7000 pcs on reel
61.172.80



Ø 1 mm
Crimpgröße 4 (0,75 - 1,0 mm²)
10 000 Stück auf Rolle
crimping size 4 (0.75 - 1.0 mm²)
10000 pcs on reel
61.173.80

Art.-Nr. Art. No.

Winkeleinbaudosen Receptacles Angled

IP 66/67

-20G-
VIBRATIONSFEST

EMV/EMC

US

SPEEDTEC®



SPEEDTEC®



A E D ■ ■ ■ ■ ■ ■ ■ ■ ■ ■ 00 0201 ■ ■ ■ ■

C chromatiert chromated

Winkeleinbaudose drehbar Receptacle Angled rotatable

mit Aussengewinde M23 x 1 und Vibrationsschutz-O-Ring, speedtec-ready, drehbar, Flanschbefestigung 25 x 25 mm, axiale O-Ring-Abdichtung with outside thread M23 x 1 and anti-vibration o-ring, speedtec-ready, rotatable, flange mount 25 x 25 mm, axial o-ring seal

A E D ■ ■ ■ ■ ■ ■ ■ ■ ■ ■ 00 0101 ■ ■ ■ ■

C chromatiert chromated

Winkeleinbaudose drehbar Receptacle Angled rotatable

für speedtec Schnellverschluss, drehbar, Flanschbefestigung 25 x 25 mm, axiale O-Ring-Abdichtung for speedtec quick lock fastener, rotatable, flange mount 25 x 25 mm, axial o-ring seal

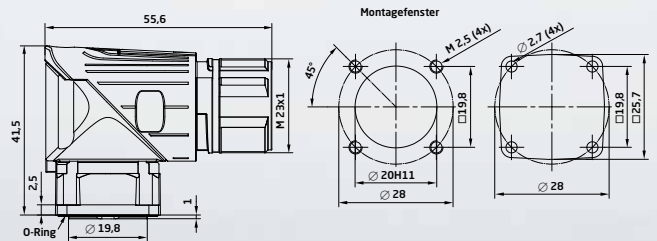
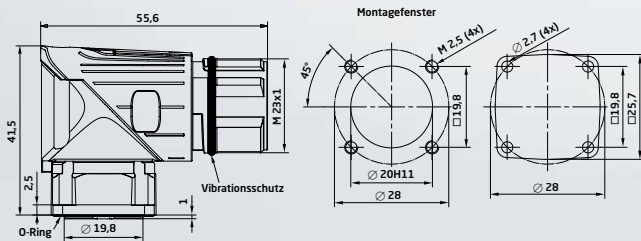

A E D ■ ■ ■ ■ ■ ■ ■ ■ ■ ■ 00 0012 ■ ■ ■ ■

C chromatiert chromated

Winkeleinbaudose drehbar Receptacle Angled rotatable

mit Aussengewinde M23 x 1 und Vibrationsschutz-O-Ring, drehbar, Flanschbefestigung 25 x 25 mm, axiale O-Ring-Abdichtung with outside thread M23 x 1 and anti-vibration o-ring, rotatable, flange mount 25 x 25 mm, axial o-ring seal

A E D ■ ■ ■ ■ ■ ■ ■ ■ ■ ■ 00 0013 ■ ■ ■ ■

C chromatiert chromated

Winkeleinbaudose drehbar Receptacle Angled rotatable

mit Aussengewinde M23 x 1 und Vibrationsschutz-O-Ring, drehbar, Flanschbefestigung 28 x 28 mm, axiale O-Ring-Abdichtung with outside thread M23 x 1 and anti-vibration o-ring, rotatable, flange mount 28 x 28 mm, axial o-ring seal

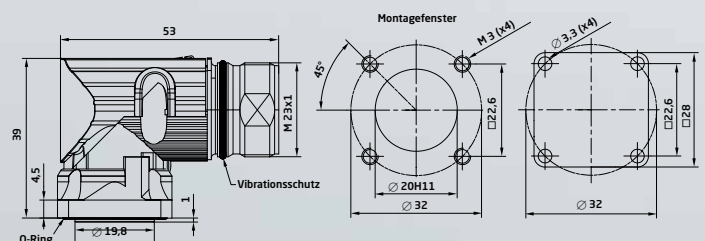
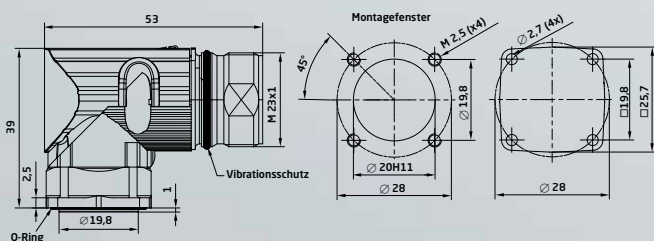



SPEEDTEC®

A E D ■ ■ ■ ■ ■ ■ ■ ■ ■ ■ 00 0200 ■ ■ ■ ■

C chromatiert chromated

Winkeleinbaudose drehbar
Receptacle Angled rotatable

mit Aussengewinde M23 x 1 und Vibrationsschutz-O-Ring, speedtec-ready, drehbar, Flanschbefestigung 28 x 28 mm, axiale O-Ring-Abdichtung
with outside thread M23 x 1 and anti-vibration o-ring, speedtec-ready, rotatable, flange mount 28 x 28 mm, axial o-ring seal

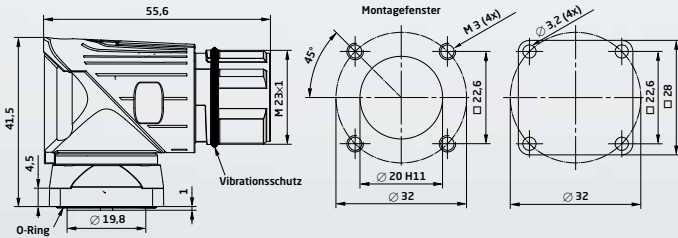

A E D ■ ■ ■ ■ ■ ■ ■ ■ ■ ■ 00 0100 ■ ■ ■ ■

C chromatiert chromated

Winkeleinbaudose drehbar
Receptacle Angled rotatable

für speedtec Schnellverschluss, drehbar, Flanschbefestigung 28 x 28 mm, axiale O-Ring-Abdichtung
for quick lock fastener, rotatable, flange mount 28 x 28 mm, axial o-ring seal

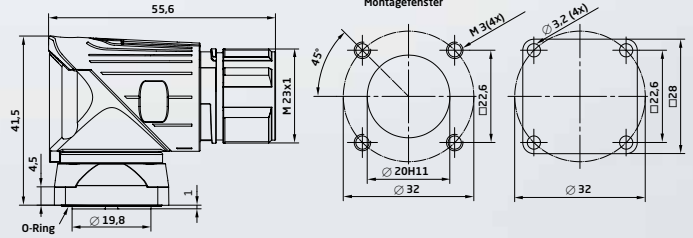

SPEEDTEC®

A E W ■ ■ ■ ■ ■ ■ ■ ■ ■ ■ 00 0214 ■ ■ ■ ■

C chromatiert chromated

Winkeleinbaudose
Receptacle Angled

mit Aussengewinde M23 x 1 und Vibrationsschutz-O-Ring, speedtec ready, Flanschbefestigung 25 x 25 mm, axiale O-Ring-Abdichtung
with outside thread M23 x 1 and anti-vibration o-ring, speedtec ready, flange mount 28 x 28 mm, axial o-ring seal

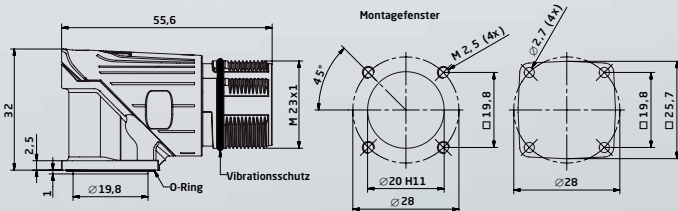

A E W ■ ■ ■ ■ ■ ■ ■ ■ ■ ■ 00 0114 ■ ■ ■ ■

C chromatiert chromated

Winkeleinbaudose
Receptacle Angled

für speedtec Schnellverschluss, Flanschbefestigung 25 x 25mm, axiale O-Ring Abdichtung
for speedtec quick lock fastener, flange mount 25 x 25mm, axial o-ring seal

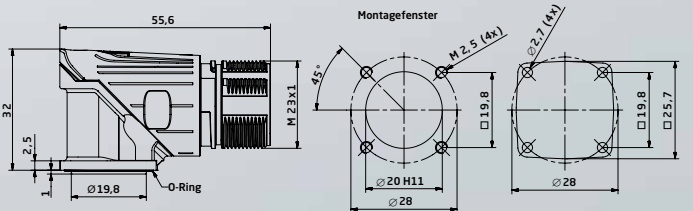

Isolierkörper und Kontakte Insulation Inserts and Contacts



6-polig P 6-pin P (6 x Ø 2 mm)

0° codiert, mit Sprengling
0° coded with retention ring

Ansicht steckseitig mating view

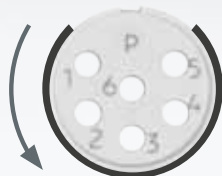

7-polig P 7-pin P (7 x Ø 2 mm)

0° codiert, mit Sprengling
0° coded with retention ring

Ansicht steckseitig mating view



6-polig E 6-pin E (6 x Ø 2 mm)

0° codiert, mit Sprengling
0° coded with retention ring

Ansicht steckseitig mating view

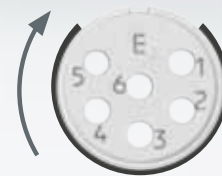

7-polig E 7-pin E (7 x Ø 2 mm)

0° codiert, mit Sprengling
0° coded with retention ring

Ansicht steckseitig mating view

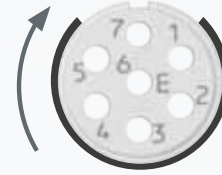

Kontaktbuchse Ø 2 mm Contact Socket Ø 2 mm Nicht im Lieferumfang enthalten Not part of product contents



Ø 2 mm
geschlitzt, Crimpbereich 0,35 - 2,5 mm²
slotted, crimping range 0.35 - 2.5 mm²
60.012.11



Ø 2 mm
geschlitzt, Lötkech 2,5 mm²
slotted, solder bucket 2.5 mm²
60.014.11



Kontaktstift Ø 2 mm Contact Pin Ø 2 mm Nicht im Lieferumfang enthalten Not part of product contents



Ø 2 mm
Crimpbereich 0,35 - 2,5 mm²
crimping range 0.35 - 2.5 mm²
61.008.11



Ø 2 mm
Lötkech 2,5 mm²
solder bucket 2.5 mm²
61.011.11

Art.-Nr. Art. No.



9-polig P 9-pin P (9 x Ø 1 mm)

uncodiert, mit Sprengling
uncoded with retention ring

Ansicht steckseitig mating view

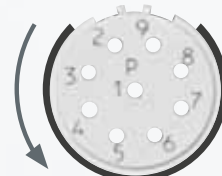

9-polig E 9-pin E (9 x Ø 1 mm)

uncodiert, mit Sprengling
uncoded with retention ring

Ansicht steckseitig mating view

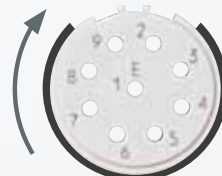

Kontaktbuchse Ø 1 mm Contact Socket Ø 1 mm Nicht im Lieferumfang enthalten Not part of product contents



Ø 1 mm
Drahtfeder, Crimpbereich 0,14 - 1,0 mm²
wire spring, crimping range 0.14 - 1.0 mm²
60.001.11



Ø 1 mm
geschlitzt, Crimpbereich 0,14 - 1,0 mm²
slotted, crimping range 0.14 - 1.0 mm²
60.011.11



Ø 1 mm
Drahtfeder, Lötkech 1,5 mm²
wire spring, solder bucket 1.5 mm²
60.004.11



Ø 1 mm
geschlitzt, Lötkech 1,5 mm²
slotted, solder bucket 1.5 mm²
60.013.11



Ø 1 mm
geschlitzt, Crimpbereich 0,03 - 0,34 mm²
slotted, crimping range 0.03 - 0.34 mm²
60.172.11

Art.-Nr. Art. No.



Kontaktstift Ø 1 mm Contact Pin Ø 1 mm Nicht im Lieferumfang enthalten Not part of product contents



Ø 1 mm
Crimpbereich 0,14 - 1,0 mm²
crimping range 0.14 - 1.0 mm²
61.004.11



Ø 1 mm
Lötkech 1,5 mm²
solder bucket 1.5 mm²
61.006.11



Ø 1 mm
Crimpbereich 0,03 - 0,34 mm²
crimping range 0.03 - 0.34 mm²
61.083.11

Art.-Nr. Art. No.

Isolierkörper und Kontakte



8+1-polig P 8+1-pin P (8 x Ø 1 mm + 1 x Ø 2 mm)

uncodiert, mit Sprengring
uncoded with retention ring

Ansicht steckseitig mating view



8+1-polig E 8+1-pin E (8 x Ø 1 mm + 1 x Ø 2 mm)

uncodiert, mit Sprengring
uncoded with retention ring

Ansicht steckseitig mating view

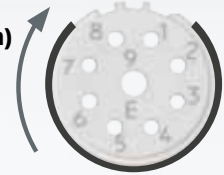

Kontaktbuchse Ø 1 mm Contact Socket Ø 1 mm Nicht im Lieferumfang enthalten Not part of product contents



Ø 1 mm
Drahtfeder, Crimpbereich 0,14 - 1,0 mm²
wire spring, crimping range 0.14 - 1.0 mm²
60.001.11



Ø 1 mm
geschlitzt, Crimpbereich 0,14 - 1,0 mm²
slotted, crimping range 0.14 - 1.0 mm²
60.011.11



Ø 1 mm
Drahtfeder, Lötkeilch 1,5 mm²
wire spring, solder bucket 1.5 mm²
60.004.11



Ø 1 mm
geschlitzt, Lötkeilch 1,5 mm²
slotted, solder bucket 1.5 mm²
60.013.11



Ø 1 mm
geschlitzt, Crimpbereich 0,03 - 0,34 mm²
slotted, crimping range 0.03 - 0.34 mm²
60.172.11

Art.-Nr. Art. No.



Kontaktbuchse Ø 2 mm Contact Socket Ø 2 mm Nicht im Lieferumfang enthalten Not part of product contents



Ø 2 mm
geschlitzt, Crimpbereich 0,35 - 2,5 mm²
slotted, crimping range 0.35 - 2.5 mm²
60.012.11



Ø 2 mm
geschlitzt, Lötkeilch 2,5 mm²
slotted, solder bucket 2.5 mm²
60.014.11

Art.-Nr. Art. No.



Kontaktstift Ø 1 mm Contact Pin Ø 1 mm Nicht im Lieferumfang enthalten Not part of product contents



Ø 1 mm
Crimpereich 0,14 - 1,0 mm²
crimping range 0.14 - 1.0 mm²
61.004.11



Ø 1 mm
Lötkeilch 1,5 mm²
solder bucket 1.5 mm²
61.006.11



Ø 1 mm
Crimpereich 0,03 - 0,34 mm²
crimping range 0.03 - 0.34 mm²
61.083.11

Art.-Nr. Art. No.



Kontaktstift Ø 2 mm Contact Pin Ø 2 mm Nicht im Lieferumfang enthalten Not part of product contents



Ø 2 mm
Crimpereich 0,35 - 2,5 mm²
crimping range 0.35 - 2.5 mm²
61.008.11



Ø 2 mm
Lötkeilch 2,5 mm²
solder bucket 2.5 mm²
61.011.11

Insulation Inserts and Contacts



12-polig P 12-pin P
(12 x Ø 1 mm)

0° codiert 0° coded

Ansicht steckseitig mating view

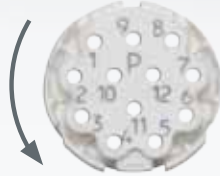

12-polig E 12-pin E
(12 x Ø 1 mm)

0° codiert 0° coded

Ansicht steckseitig mating view

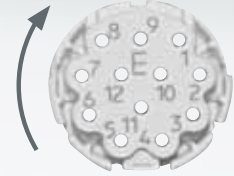

17-polig P 17-pin P
(17 x Ø 1 mm)

0° codiert 0° coded

Ansicht steckseitig mating view



17-polig E 17-pin E
(17 x Ø 1 mm)

0° codiert 0° coded

Ansicht steckseitig mating view

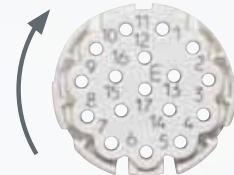

Kontaktbuchse Ø 1 mm Contact Socket Ø 1 mm
Nicht im Lieferumfang enthalten Not part of product contents



Ø 1 mm
Drahtfeder, Crimpbereich 0,14 - 1,0 mm²
wire spring, crimping range 0.14 - 1.0 mm²
60.001.11



Ø 1 mm
geschlitzt, Crimpbereich 0,14 - 1,0 mm²
slotted, crimping range 0.14 - 1.0 mm²
60.011.11



Ø 1 mm
Drahtfeder, Lötkelch 1,5 mm²
wire spring, solder bucket 1.5 mm²
60.004.11



Ø 1 mm
geschlitzt, Lötkelch 1,5 mm²
slotted, solder bucket 1.5 mm²
60.013.11



Ø 1 mm
geschlitzt, Crimpbereich 0,03 - 0,34 mm²
slotted, crimping range 0.03 - 0.34 mm²
60.172.11



Kontaktstift Ø 1 mm Contact Pin Ø 1 mm
Nicht im Lieferumfang enthalten Not part of product contents



Ø 1 mm
Crimpbereich 0,14 - 1,0 mm²
crimping range 0.14 - 1.0 mm²
61.004.11



Ø 1 mm
Lötkelch 1,5 mm²
solder bucket 1.5 mm²
61.006.11



Ø 1 mm
Crimpbereich 0,03 - 0,34 mm²
crimping range 0.03 - 0.34 mm²
61.083.11



Bandkontaktbuchse Ø 1 mm Bandoleer Contact Socket Ø 1 mm
Nicht im Lieferumfang enthalten Not part of product contents



Ø 1 mm
Crimprgröße 1 (0,03 - 0,08 mm²)
7000 Stück auf Rolle
crimping size 1 (0.03 - 0.08 mm²)
7000 pcs on reel
60.198.80



Ø 1 mm
Crimprgröße 2 (0,08 - 0,20 mm²)
7000 Stück auf Rolle
crimping size 2 (0.08 - 0.20 mm²)
7000 pcs on reel
60.199.80



Ø 1 mm
Crimprgröße 3 (0,20 - 0,52 mm²)
7000 Stück auf Rolle
crimping size 3 (0.20 - 0.52 mm²)
7000 pcs on reel
60.200.80



Ø 1 mm
Crimprgröße 4 (0,75 - 1,0 mm²)
10000 Stück auf Rolle
crimping size 4 (0.75 - 1.0 mm²)
10000 pcs on reel
60.201.80



Bandkontaktstift Ø 1 mm Bandoleer Contact Pin Ø 1 mm
Nicht im Lieferumfang enthalten Not part of product contents



Ø 1 mm
Crimprgröße 1 (0,03 - 0,08 mm²)
7000 Stück auf Rolle
crimping size 1 (0.03 - 0.08 mm²)
7000 pcs on reel
61.170.80



Ø 1 mm
Crimprgröße 2 (0,08 - 0,20 mm²)
7000 Stück auf Rolle
crimping size 2 (0.08 - 0.20 mm²)
7000 pcs on reel
61.171.80



Ø 1 mm
Crimprgröße 3 (0,20 - 0,52 mm²)
7000 Stück auf Rolle
crimping size 3 (0.20 - 0.52 mm²)
7000 pcs on reel
61.172.80



Ø 1 mm
Crimprgröße 4 (0,75 - 1,0 mm²)
10000 Stück auf Rolle
crimping size 4 (0.75 - 1.0 mm²)
10000 pcs on reel
61.173.80

Isolierkörper und Kontakte Insulation Inserts and Contacts



16+3-polig P 16+3-pin P (16 x Ø 1 mm + 3 x Ø 1,5 mm)

0° codiert, mit Sprengring
0° coded with retention ring

Ansicht steckseitig mating view

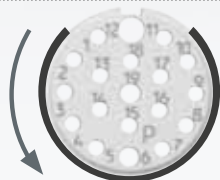

16+3-polig E 16+3-pin E (16 x Ø 1 mm + 3 x Ø 1,5 mm)

0° codiert, mit Sprengring
0° coded with retention ring

Ansicht steckseitig mating view

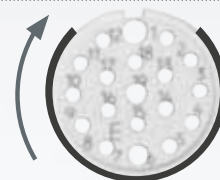

Kontaktbuchse Ø 1 mm Contact Socket Ø 1 mm Nicht im Lieferumfang enthalten Not part of product contents



Ø 1 mm

Drahtfeder, Crimpbereich 0,14 - 1,0 mm²
wire spring, crimping range 0,14 - 1,0 mm²
60.001.11



Ø 1 mm

geschlitzt, Crimpbereich 0,14 - 1,0 mm²
slotted, crimping range 0,14 - 1,0 mm²
60.011.11



Ø 1 mm

Drahtfeder, Lötkehl 1,5 mm²
wire spring, solder bucket 1.5 mm²
60.004.11



Ø 1 mm

geschlitzt, Lötkehl 1,5 mm²
slotted, solder bucket 1.5 mm²
60.013.11



Ø 1 mm

geschlitzt, Crimpbereich 0,03 - 0,34 mm²
slotted, crimping range 0,03 - 0,34 mm²
60.172.11



Kontaktbuchse Ø 1,5 mm Contact Socket Ø 1,5 mm Nicht im Lieferumfang enthalten Not part of product contents



Ø 1,5 mm

geschlitzt, Crimpbereich 0,24 - 1,0 mm²
slotted, crimping range 0,24 - 1,0 mm²
60.070.11



Ø 1,5 mm

geschlitzt, Lötkehl 1,5 mm²
slotted, solder bucket 1.5 mm²
60.173.11



Kontaktstift Ø 1 mm Contact Pin Ø 1 mm Nicht im Lieferumfang enthalten Not part of product contents



Ø 1 mm

Crimpereich 0,14 - 1,0 mm²
crimping range 0,14 - 1,0 mm²
61.004.11



Ø 1 mm

Lötkehl 1,5 mm²
solder bucket 1.5 mm²
61.006.11



Ø 1 mm

Crimpereich 0,03 - 0,34 mm²
crimping range 0,03 - 0,34 mm²
61.083.11



Ø 1,5 mm

Crimpereich 0,24 - 1,0 mm²
crimping range 0,24 - 1,0 mm²
61.072.11



Ø 1,5 mm

Lötkehl 1,5 mm²
solder bucket 1.5 mm²
61.152.11



Bandkontaktbuchse Ø 1 mm Bandoleer Contact Socket Ø 1 mm Nicht im Lieferumfang enthalten Not part of product contents



Ø 1 mm

Crimpgröße 1 (0,03 - 0,08 mm²)
7000 Stück auf Rolle
crimping size 1 (0,03 - 0,08 mm²)
7000 pcs on reel
60.198.80



Ø 1 mm

Crimpgröße 2 (0,08 - 0,20 mm²)
7000 Stück auf Rolle
crimping size 2 (0,08 - 0,20 mm²)
7000 pcs on reel
60.199.80



Ø 1 mm

Crimpgröße 3 (0,20 - 0,52 mm²)
7000 Stück auf Rolle
crimping size 3 (0,20 - 0,52 mm²)
7000 pcs on reel
60.200.80



Ø 1 mm

Crimpgröße 4 (0,75 - 1,0 mm²)
10 000 Stück auf Rolle
crimping size 4 (0,75 - 1,0 mm²)
10000 pcs on reel
60.201.80



Bandkontaktstift Ø 1 mm Bandoleer Contact Pin Ø 1 mm Nicht im Lieferumfang enthalten Not part of product contents



Ø 1 mm

Crimpgröße 1 (0,03 - 0,08 mm²)
7000 Stück auf Rolle
crimping size 1 (0,03 - 0,08 mm²)
7000 pcs on reel
61.170.80



Ø 1 mm

Crimpgröße 2 (0,08 - 0,20 mm²)
7000 Stück auf Rolle
crimping size 2 (0,08 - 0,20 mm²)
7000 pcs on reel
61.171.80



Ø 1 mm

Crimpgröße 3 (0,20 - 0,52 mm²)
7000 Stück auf Rolle
crimping size 3 (0,20 - 0,52 mm²)
7000 pcs on reel
61.172.80



Ø 1 mm

Crimpgröße 4 (0,75 - 1,0 mm²)
10 000 Stück auf Rolle
crimping size 4 (0,75 - 1,0 mm²)
10000 pcs on reel
61.173.80

Notizen
Notes

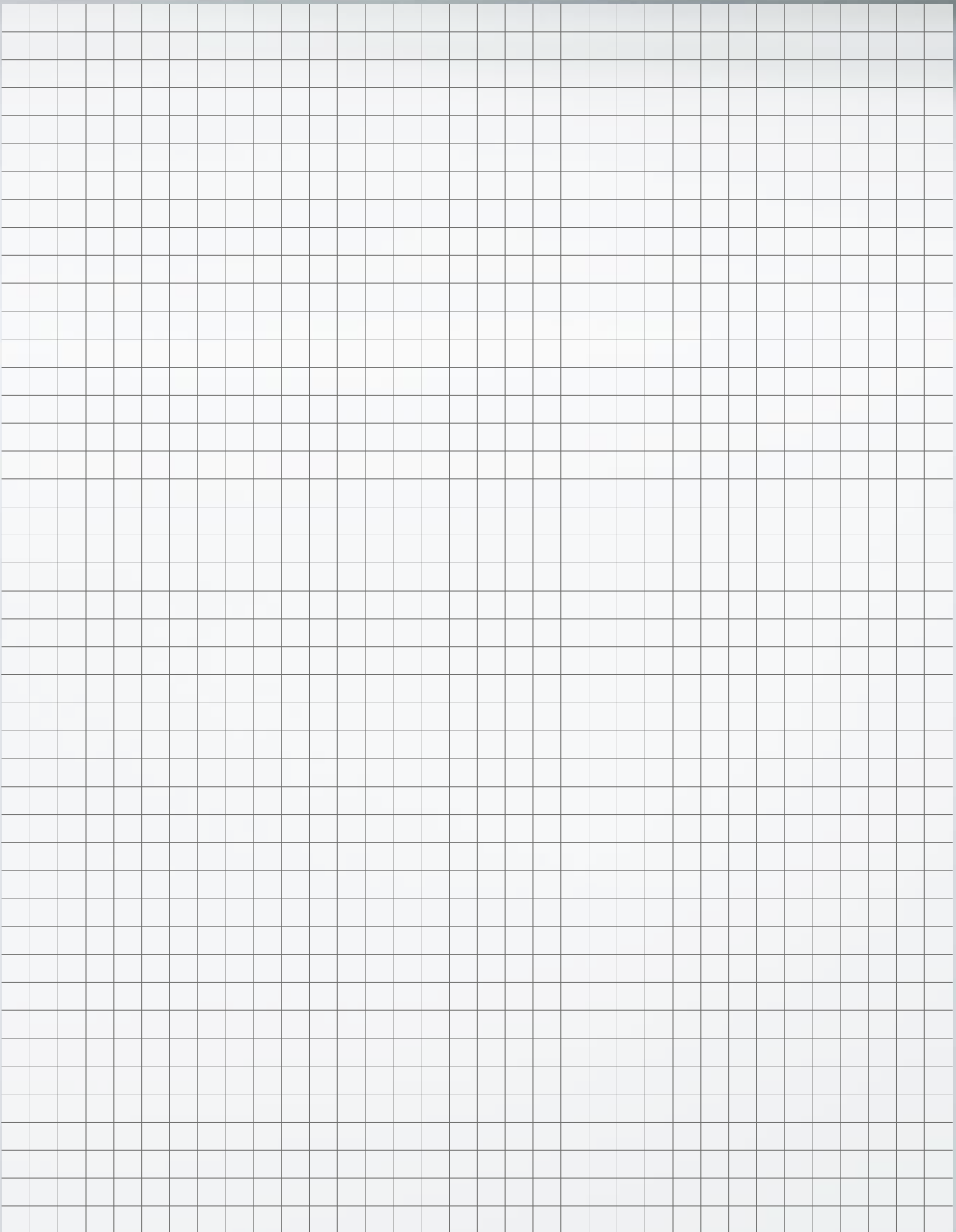

Kabelklemmungen Cable Clamps



Kronenklemmung Crown Clamp

Kabelklemmbereich 4,2 - 6,6 mm cable clamping range 4.2 - 6.6 mm

Integrierte Dichtung, Verdrehsicherung und koaxiale Kronen-Schirmanbindung.
Keine Schirmkürzung erforderlich. Integrated seal, anti-twist protection and coaxial crown shield connection. No shield trimming required.



Kabelklemmbereich 7,5 - 12,0 mm cable clamping range 7.5 - 12.0 mm



Kabelklemmbereich 9,5 - 14,5 mm cable clamping range 9.5 - 14.5 mm



Lamellenklemmung Lamella Clamp

Kabelklemmbereich 4,2 - 6,6 mm cable clamping range 4.2 - 6.6 mm

Integrierte Dichtung, Verdrehsicherung und koaxiale Schirmanbindung
Integrated seal, anti-twist protection and coaxial shield connection



Kabelklemmbereich 7,5 - 12,0 mm cable clamping range 7.5 - 12.0 mm



Kabelklemmbereich 9,5 - 14,5 mm cable clamping range 9.5 - 14.5 mm



Kabelklemmbereich 14,0 - 17,0 mm cable clamping range 14.0 - 17.0 mm



Knopfklammung Ball Clamp

Kabelklemmbereich 9,0 - 14,0 mm cable clamping range 9.0 - 14.0 mm

Integrierte 2-Lippen-Dichtung und koaxiale Schirmanbindung.
Integrated double lip seal and coaxial shield connection.



Kabelklemmungen Cable Clamps



Kronenklemmung Crown Clamp

Kabelklemmbereich 4,2 - 6,6 mm cable clamping range 4.2 - 6.6 mm

Integrierte Dichtung, Verdrehsicherung und koaxiale Kronen-Schirmanbindung.
Keine Schirmkürzung erforderlich. Integrated seal, anti-twist protection and coaxial crown shield connection. No shield trimming required.



Kabelklemmbereich 7,5 - 12,0 mm cable clamping range 7.5 - 12.0 mm



Kabelklemmbereich 9,5 - 14,5 mm cable clamping range 9.5 - 14.5 mm



Lamellenklemmung Lamella Clamp

Kabelklemmbereich 4,2 - 6,6 mm cable clamping range 4.2 - 6.6 mm

Integrierte Dichtung, Verdrehsicherung und koaxiale Schirmanbindung
Integrated seal, anti-twist protection and coaxial shield connection



Kabelklemmbereich 7,5 - 12,0 mm cable clamping range 7.5 - 12.0 mm



Kabelklemmbereich 9,5 - 14,5 mm cable clamping range 9.5 - 14.5 mm



Kabelklemmbereich 14,0 - 17,0 mm cable clamping range 14.0 - 17.0 mm



Knopfklammung Ball Clamp

Kabelklemmbereich 9,0 - 14,0 mm cable clamping range 9.0 - 14.0 mm

Integrierte 2-Lippen-Dichtung und koaxiale Schirmanbindung.
Integrated double lip seal and coaxial shield connection.





locktec

Die konfektionierbare „Revolution“ ohne Umspritzvorgang

Durch die unlösbare Verbindung zwischen Gehäuse und Ummantelung wird beim Versuch den Steckverbinder zu öffnen der Mantel zerstört.

Manipulationssicher und trotzdem konfektionierbar.

The Assembly-Ready Revolution Without Overmold

The coat of the inseparable connection between housing and cover will be destroyed when trying to open the connector.

Tamper-resistant and assembly-ready nonetheless.

locktec - unsere Kunststoffummantelten

- Mit Knickschutz
- Schutzart IP 66/67
- Robustes Metallgehäuse innen
- EMV-Schirmung
- speedtec oder Schraubverschluss
- Individuelle Beschriftung und Farbe der Ummantelung
- Alle gängigen Kabel/Spezialkabel in beliebigen Längen
- Alle Kunststoffe nach UL 94/V0
- Alle gängigen Polbilder erhältlich
- Individuelle Kabellängen

Für weitere Details und Anfragen richten Sie sich bitte an Ihren Intercontec-Vertriebspartner.

locktec - Plastic Coated Connectors

- bend protection
- IP 66/67 protection
- robust metal housing
- EMC-shielding
- speedtec or screw fastener
- individual labelling and colour
- standard and special cables in different lengths
- plastics UL 94/V0 certified
- all standard pin layouts
- individual cable lengths

For further details and specific requests please contact your Intercontec distribution partner.



Die fertig montierten Steckverbinder und Einzelkomponenten werden sorgfältig geprüft und in geeignete, individuell auf die Produkte abgestimmte Behältnisse verpackt, palettiert, etikettiert und versandt.

Assembled connectors and single components are tested thoroughly, packed in suitable individually customized boxes, labelled, palletized and shipped.



Auf Wunsch liefern wir Steckverbinder auch als kundenspezifischen Service-Pack (siehe Abbildung oben) mit Montageanleitung aus.

On request we also offer customer specific service packs which include assembly instructions (see picture above).



A2.162.01

Knickschutz bis Ø 11 mm mit Klemmring Bend Protection up to Ø 11 mm with Clamp Ring

geeignet für alle Kabelklemmungen Außer: Knopfklammung, Winkelstecker, twintec B, Busgehäuse Ø 27 mm und 10-polige Steckverbinder suitable for all cable clamps expect: ball clamps, angled plugs, twintec B, bus housings Ø 27 mm and 10-pin connectors



A2.164.01

Knickschutz bis Ø 11 mm mit Klemmring Bend Protection up to Ø 11 mm with Clamp Ring

geeignet für Winkelstecker, twintec B, Busstecker Ø 27mm und 10-polige Steckverbinder Außer: Knopfklammung suitable for all angled plugs, twintec B, bushousings Ø 27 mm and 10-pin connectors



A2.163.01

Knickschutz Ø 11 mm - Ø 14 mm mit Klemmring Bend Protection Ø 11 mm - Ø 14 mm with Clamp Ring

geeignet für alle Kabelklemmungen Außer: Knopfklammung, Winkelstecker, twintec B, Busgehäuse Ø 27 mm und 10-polige Steckverbinder suitable for all cable clamps expect: ball clamps, angled plugs, twintec B, bus housings Ø 27 mm and 10-pin connectors



A2.165.01

Knickschutz Ø 11 mm - Ø 14 mm mit Klemmring Bend Protection Ø 11 mm - Ø 14 mm with Clamp Ring

geeignet für Winkelstecker, twintec B, Busstecker Ø 27mm und 10-polige Steckverbinder Außer: Knopfklammung suitable for all angled plugs, twintec B, bushousings Ø 27 mm and 10-pin connectors



A2.041.01

Klemmringadapter M20 x 1,5 Clamp Ring Adaptor M20 x 1.5

geeignet für alle Kabelabgänge Außer: Knopfklammung, Winkelgehäuse, twintec B, Busgehäuse Ø 27 mm und 10-polige Steckverbinder suitable for all cable outlets Except: Ball clamps, angled housings, twintec B, bus housings Ø 27 mm and 10-pin connectors



A2.044.01

Klemmringadapter M20 x 1,5 Clamp Ring Adaptor M20 x 1.5

mit Spezialdistanzhülse bei Verwendung ohne Intercontec Kabelklemmung Außer: Winkelgehäuse, Busgehäuse Ø 27 mm und 10-polige Steckverbinder with special distance sleeve for compatibility with non-Intercontec cable clamps Except: Angled housings, bus housings Ø 27 mm and 10-pin connectors



FF.046.00

Einschraubadapter Screw-In Adapter

für Steckverbinder mit Flanschbefestigung 25 x 25 mm mit Einschraubgewinde M20 x 1,5, Gewindelänge 7,5 mm. Als Servicepack in Folienbeutel mit 4 Befestigungsschrauben M2,5. for connectors, flange size 25 x25 mm with screw-in thread M20 x 1,5, threadlength 7,5 mm Servicepack in plastic bag with 4 screw: M2,5

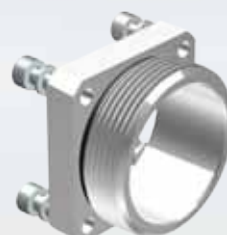

FF.047.00

Einschraubadapter Screw-In Adapter

für Steckverbinder mit Flanschbefestigung 25 x 25 mm mit Einschraubgewinde M25 x 1,5, Gewindelänge 8 mm. Als Servicepack in Folienbeutel mit 4 Befestigungsschrauben M2,5. for connectors, flange size 25 x25 mm with screw-in thread M25 x 1,5, threadlength 8 mm Servicepack in plastic bag with 4 screw: M2,5



A2.043.01

Klemmringadapter M25 x 1,5 Clamp Ring Adaptor M25 x 1,5

geeignet für Kabelabgänge von Winkelgehäuse, twintec B, Busgehäuse Ø 27 mm und 10-polige Steckverbinder suitable for cable outlets from angled housings, twintec B, bus housings Ø 27 mm and 10-pin connectors



A2.045.01

Klemmringadapter M25 x 1,5 Clamp Ring Adaptor M25 x 1,5

mit Spezialdistanzhülse bei Verwendung ohne Intercontec Kabelklemmung bei Busgehäuse Ø 27 mm und 10-polige Steckverbinder with special distance sleeve for compatibility with non-Intercontec cable clamps using bus housings Ø 27 mm and 10-pin connectors



81.006.90

Vibrationsschutz O-Ring anti-vibration O-Ring

FPM, gleitbeschichtet, zur Nachrüstung von speedtec Einbaudosen und Kupplungen für die Verwendung als vibrationsgeschützte Schraubvariante. FPM anti-vibration O-Ring, anti-friction coated, for re-fitting speedtec receptacle connectors and extensions for compatibility with threaded mating connectors.

Verpackungseinheit: 100 Stück
Packaging unit: 100 pieces

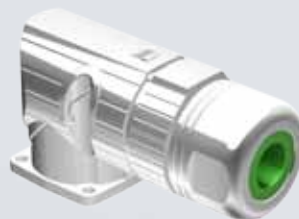

VAF427A.....

Winkelverschraubung Cable Gland, angled

mit Flanschbefestigung 25 x 25mm, EMV-Schirmung und variabler Kabelklemmung (Kronenklemmung) Hänge mount 25 x 25mm, EMC-Shielding and variable cable clamp

VAF427A382002000 mit Kornenklemmung Ø 3,5 - 5,6mm cable clamping range Ø 3.5 - 5.6mm

VAF427A392002000 mit Kornenklemmung Ø 4,5 - 8,5mm cable clamping range Ø 4.5 - 8.5mm

VAF427A412002000 mit Kornenklemmung Ø 6,0 - 10,0mm cable clamping range Ø 6.0 - 10.0mm

VAF427A402002000 mit Kornenklemmung Ø 9,0 - 13,2mm cable clamping range Ø 9.0 - 13.2mm

VAF427A732002000 mit Kornenklemmung Ø 9,0 - 14,7mm cable clamping range Ø 9.0 - 14.7mm

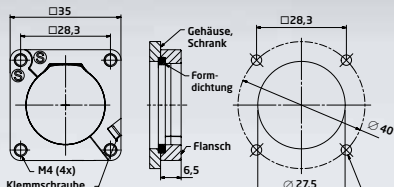

E0.223.02

Metallflansch, klappbar
Metal Flange, Hinged

mit Dichtring optional auf gerade Gehäuse klemmbar Außer: Busgehäuse Ø 27 mm, twintec B und 10-polige Steckverbinder
with sealing ring; can be used with straight housing alternatively Except: bus housing Ø 27 mm, twintec B and 10-pin connectors

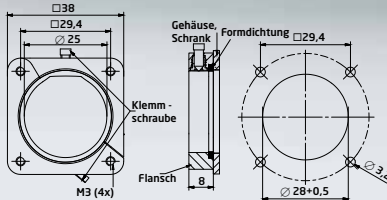

E0.117.00

Kunststoffflansch, klappbar
Plastic Flange, Hinged

mit Dichtring optional auf gerade Gehäuse klemmbar Außer: Busgehäuse Ø 27 mm, twintec B und 10-polige Steckverbinder
with sealing ring; can be used with straight housing alternatively Except: bus housing Ø 27 mm, twintec B and 10-pin connectors

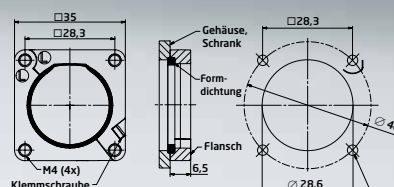

E0.222.02

Metallflansch, klappbar
Metal Flange, Hinged

mit Dichtring optional auf gerade Busgehäuse Ø 27 mm, twintec B und 10-polige Steckverbinder klemmbar
with sealing ring; can be used alternatively with straight bus housing Ø 27 mm, twintec B and 10-pin connectors



8B.069.00

Kunststoff-Verschlusskappe
Plastic Protection Cap

passend zu Stecker speedtec und schraub inkl. Dichtung und Halteband für die Befestigung. Nicht verwendbar für Winkelgehäuse, Busgehäuse Ø 27 mm, twintec B und 10-polige Steckverbinder
suitable for plugs speedtec and screw version includes seal and retaining band for attachment; not compatible with angled housing, bus housing Ø 27 mm, twintec B and 10-pin connectors



8B.070.00

Kunststoff-Verschlusskappe
Plastic Protection Cap

passend zu Stecker speedtec und schraub inkl. Dichtung und Halteband für die Bestigung Für Winkelgehäuse, Busgehäuse Ø 27 mm, twintec B und 10-polige Steckverbinder
suitable for plugs speedtec and screw version includes seal and retaining band for attachment; for angled and bus housing Ø 27 mm, twintec B and 10-pin connectors



8B.071.00

Kunststoff-Verschlusskappe
Plastic Protection Cap

zu Einbaudosen und Kupplungen speedtec und schraub inkl. Halteband für die Bestigung
suitable for receptacles and extensions speedtec and screw version; includes retaining band for attachment



8B.011.01

Metall-Verschlusskappe
Metal Protection Cap

passend zu Einbaudosen und Kupplungen speedtec und schraub inkl. Dichtung und Seil mit Befestigungsöse
suitable for receptacles and extensions speedtec and screw version; includes seal and cord with eyelet for attachment



8B.013.01

Metall-Verschlusskappe
Metal Protection Cap

passend zu Steckern und Durchführungen mit M23 Schraubgewinde inkl. Dichtung und Seil mit Befestigungsöse
suitable for plugs and bulkhead connectors with M23 thread; includes seal and cord with eyelet for attachment



8A.002.00

Kunststoff-Hutstopfen
Plastic Protection Cap

passend für Einbaudosen und Kupplungen
suitable for receptacles and extensions



CO.235.00

**Digitale Crimpzange (Crimpset mit 2 Locators)
Digital Crimp Tool (Crimp Set with 2 Locator units)**

für Kontakte mit Aderquerschnitt von 0,03 - 2,5 mm². Die verschiedenen Kontakte können mit einem der zwei einstellbaren Locators verarbeitet werden. Stabile Ausführung, selbst kalibrierbar, mit 2 Locators und Koffer.

for contacts wire gauge 0.03 - 2.5 mm². Two adjustable locator units allow the processing of various contacts. Solid design, self-calibrating, with 2 locator units and case.



CO.236.00

**Digitale Crimpzange (Crimpset mit 2 Locators)
Digital Crimp Tool (Crimp Set with 2 Locator units)**

für Kontakte mit Aderquerschnitt von 0,1 - 4,0 mm². Die verschiedenen Kontakte können mit einem der zwei einstellbaren Locators verarbeitet werden. Stabile Ausführung, selbst kalibrierbar, mit 2 Locators und Koffer.

for contacts wire gauge 0.1 - 4.0 mm². Two adjustable locator units allow the processing of various contacts. Solid design, self-calibrating, with 2 locator units and case.



CO.242.00

**Locator für CO.235.00
Locator for CO.235.00**

Im Lieferumfang enthalten.
Part of product contents.

Buchsen Sockets	Stifte Pins
60.001.11	61.004.11
60.011.11	61.072.11
60.070.11	61.083.11
60.159.11	61.141.11
60.171.11	61.151.11
60.172.11	61.178.11
60.205.11	



CO.244.00

**Locator für CO.236.00
Locator for CO.236.00**

Im Lieferumfang enthalten.
Part of product contents.

Buchsen Sockets	Stifte Pins
60.001.11	61.004.11 61.055.11
60.003.11	61.009.11 61.097.11
60.011.11	61.010.11 61.098.11
60.023.11	61.020.11 61.107.11
	61.021.11 61.108.11
	61.022.11 61.193.11
	61.023.11 61.194.11
	61.027.11 61.216.11



CO.243.00

**Locator für CO.235.00
Locator for CO.235.00**

Im Lieferumfang enthalten.
Part of product contents.

Buchsen Socket	Stifte Pins
60.197.11	61.009.11
	61.020.11
	61.167.11



CO.245.00

**Locator für CO.236.00
Locator for CO.236.00**

Im Lieferumfang enthalten.
Part of product contents.

Buchsen Sockets	Stifte Pins
60.012.11	61.008.11
60.070.11	61.072.11
60.159.11	61.141.11
60.162.11	61.145.11
60.197.11	61.167.11
60.204.11	61.176.11
60.208.11	61.180.11
60.216.11	61.189.11



WA10043

Abisolier- und Crimpmaschine Stripcrimp 750
Stripping and Crimping Machine Stripcrimp 750

für Ø 1 mm und Ø 2 mm Bandkontakte, Automatisches Abisolieren und Crimpen in einem Arbeitsgang, 50 % Zeitersparnis durch schnellere Verarbeitung. Leichte Bedienbarkeit, Crimpwerkzeuge schnell austauschbar, servicefreundlich, mit Crimpüberwachung.
for Ø 1 mm and Ø 2 mm bandoleer contacts. Strips and crimps automatically in one step, 50 % time saving due to faster processing. Easy handling, crimp tool can be changed quickly, easy to service, with crimp quality control.

Buchsen Sockets	Stifte Pins	Crimpbereich / -größe Crimping Range / Size	Werkzeug-Nr. Tool No.
60.198.80 Ø 1mm		0,03-0,08mm ² / 1	WM10241
60.199.80 Ø 1mm		0,08-0,20mm ² / 2	WM10242
60.200.80 Ø 1mm		0,20-0,52mm ² / 3	WM10243
60.201.80 Ø 1mm		0,75-1,00mm ² / 4	WM10244
	61.170.80 Ø 1mm	0,03-0,08mm ² / 1	WM10241
	61.171.80 Ø 1mm	0,08-0,20mm ² / 2	WM10242
	61.172.80 Ø 1mm	0,20-0,52mm ² / 3	WM10243
	61.173.80 Ø 1mm	0,75-1,00mm ² / 4	WM10244
60.046.21 Ø 2mm		1,00-2,50mm	WM10246



CO.201.00

Crimpzange, mittel
Crimp Tool, mid-size

für Ø 1 mm und Ø 2 mm Kontakte bis Aderquerschnitt 4 mm², inklusive Positionierer
for Ø 1 mm and Ø 2 mm contacts max wire gauge 4 mm², includes positioner

Passende Positioniereinsätze: siehe unten
For compatible positioning inserts see below



CO.217.00

Pneumatische Crimpzange
Pneumatic Crimp Tool

für Ø 1 mm und Ø 2 mm Kontakte bis Aderquerschnitt 4,0 mm² inklusive Positionierer, Standfuß, Luftschlauch und Fußschalter
for Ø 1 mm and Ø 2 mm contacts max wire gauge 4 mm², includes positioner, standing support, air hose and foot switch

Passende Positioniereinsätze: siehe unten
For compatible positioning inserts see below



CO.003.00

Positioniereinsatz für Ø 1 mm Kontakte
Positioning Insert for Ø 1 mm Contacts

passend für Crimpzangen CO.201.00 und CO.217.00
compatible with crimp tools CO.201.00 and CO.217.00

Buchsen Sockets	Stifte Pins
60.001.11	61.004.11
60.011.11	



CO.048.00

Positioniereinsatz für Ø 1,5 mm Kontakte
Positioning Insert for Ø 1.5 mm Contacts

passend für Crimpzangen CO.201.00 und CO.217.00
compatible with crimp tools CO.201.00 and CO.217.00

Buchsen Sockets	Stifte Pins
60.070.11	61.072.11



CO.012.00

Positioniereinsatz für Ø 2 mm Kontakte
Positioning Insert for Ø 2 mm Contacts

passend für Crimpzangen CO.201.00 und CO.217.00
compatible with crimp tools CO.201.00 and CO.217.00

Buchsen Sockets	Stifte Pins
60.012.11	61.008.11



C0.101.00

Crimpzange, klein
Crimp Tool, small

für Ø 1 mm Kontakte bis Aderquerschnitt 1,5 mm², inklusive Positionierer. Komplet mit Positioniereinsatz.
for Ø 1 mm contacts, max wire gauge 1.5 mm², includes positioner and locator

Buchsen Sockets	Stifte Pins
60.001.11	61.004.11
60.011.11	61.083.11
60.159.11	61.141.11
60.172.11	



C0.216.00

Pneumatische Crimpzange
Pneumatic Crimp Tool

für Ø 1 mm Kontakte bis Aderquerschnitt 1,5 mm², inklusive Positionierer und Locator, Standfuß, Luftschlauch und Fußschalter
for Ø 1 mm contacts max wire gauge 1.5 mm², includes positioner and locator, standing support, air hose and foot switch

Buchsen Sockets	Stifte Pins
60.001.11	61.004.11
60.011.11	61.083.11
60.159.11	61.141.11
60.172.11	



C0.246.00

Crimpzange für Bandkontakt
Crimp Tool for Bandoleer Contacts

für Bandkontakte Ø 1 mm, Crimpbereiche 0,03 - 0,08 mm² und 0,75 - 1,00 mm², Rollenmagazin im Lieferumfang nicht enthalten
for bandoleer contacts Ø 1 mm, crimp range 0.03 - 0.08 mm² and 0.75 - 1.00 mm², reel is not part of product contents

Bandkontaktbuchse Ø 1 mm Bandoleer Contact Socket Ø 1 mm	Crimpbereich Crimping Range	Verpackungseinheit Packaging Unit
60.198.80.022	0,03 - 0,08 mm ²	400 Stück auf Rolle 400 pieces on reel
60.201.80.021	0,75 - 1,00 mm ²	280 Stück auf Rolle 280 pieces on reel

Bandkontaktstifte Ø 1 mm Bandoleer Contact Pin Ø 1 mm	Crimpbereich Crimping Range	Verpackungseinheit Packaging Unit
61.170.80.026	0,03 - 0,08 mm ²	400 Stück auf Rolle 400 pieces on reel
61.173.80.027	0,75 - 1,00 mm ²	280 Stück auf Rolle 280 pieces on reel



C0.078.00

Crimpzange für Bandkontakt
Crimp Tool for Bandoleer Contacts

für Bandkontakte Ø 1 mm, Crimpbereiche 0,08 - 0,20 mm² und 0,20 - 0,52 mm², Rollenmagazin im Lieferumfang nicht enthalten
for bandoleer contacts Ø 1 mm, crimp range 0.08 - 0.20 mm² and 0.20 - 0.52 mm², reel is not part of product contents

Bandkontaktbuchse Ø 1 mm Bandoleer Contact Socket Ø 1 mm	Crimpbereich Crimping Range	Verpackungseinheit Packaging Unit
60.199.80.022	0,08 - 0,20 mm ²	400 Stück auf Rolle 400 pieces on reel
60.200.80.021	0,20 - 0,52 mm ²	380 Stück auf Rolle 380 pieces on reel

Bandkontaktstifte Ø 1 mm Bandoleer Contact Pin Ø 1 mm	Crimpbereich Crimping Range	Verpackungseinheit Packaging Unit
61.171.80.026	0,08 - 0,20 mm ²	400 Stück auf Rolle 400 pieces on reel
61.172.80.027	0,20 - 0,52 mm ²	380 Stück auf Rolle 380 pieces on reel



C6.111.00

Bestückungshilfe für Signalisierkörper
Fitting Tool for Signal Insulator

hält den Signalisierkörper in Montagestellung und verhindert beim Einbau der Kontakte ein unbeabsichtigtes Verriegeln
keeps signal insulator in mounting position and prevents accidental locking



C4.016.00

Ausbauwerkzeug für Signalisierkörper
Removing Tool for Signal Insulator

entriegelt den Isolierkörper aus Einbaudosengehäuse
unlocks signal insulator in receptacle



C6.018.00

Deckelmontagewerkzeug
Mounting Tool for Lid

zum Verriegeln des Deckels bei Winkelgehäusen mit Deckelhaltefeder
to lock the top part of angled housings with lid retaining spring



C6.041.00

Deckelmontagewerkzeug, kurz
Lid Mounting Tool, Short

zum Verriegeln des Deckels bei Winkelgehäusen mit Deckelhaltefeder bei engen Platzverhältnissen
to lock the top part of angled housings with lid retaining spring where space is limited



C8.004.00

Überwurfmutter Montagewerkzeug
Assembly Tool for Coupling Nut

zum Verriegeln und Lösen der gerippten Überwurfmutter bei engen Platzverhältnissen. Einstellbares Drehmoment. Set im Koffer
for locking and unlocking corrugated coupling nut where space is limited. Adjustable torque. Set in case



C5.005.00

Montagewerkzeug für Signalisierkörper
Assembly Tool for Signal Insulator

Einbauhilfe zur Verriegelung des konfektionierten Isolierkörpers in Einbaudosen, robuste Edelstahlausführung
fitting tool for locking assembled signal insulator in receptacle, solid stainless steel version



C5.019.00

Montagewerkzeug für Signalisierkörper
Assembly Tool for Signal Insulator

Einbauhilfe zur Verriegelung des konfektionierten Isolierkörpers in Codierhülse der Winkleinbaudosen, Kunststoffausführung
fitting tool for locking assembled signal insulator in receptacle angled, plastic version



C6.019.00

Justierhebel für drehbare Winkleinbaudosen
Adjusting Lever for Rotatable Receptacles

zur Einstellung der gewünschten Abgangsrichtung des Kabels bei frei drehbaren Winkleinbaudosen
for setting direction of cable outlet of freely rotatable angled receptacles



C6.004.00

Kabeleinführdorn
Bolt for Cable Insertion

Einfädlungshilfe für Kabel ab Ø 10 mm bei Verwendung der Knopfklammer
insertion tool for cables Ø 10 mm min. using ball clamp



VA.002.00

Spannvorrichtung
Fixture

für das schonende Spannen von Geradsteckern beim Aufschrauben der Kabelklammer
for gently tightening straight connectors to screw on cable clamp

Auf Anfrage informieren wir Sie über verfügbare Sonderlösungen und weiteren, vielfältigen Variationsmöglichkeiten wie z. B.:

- **Edelstahl Steckverbinder** für Chemische- und Lebensmittelindustrie sowie für den Schiffsbau
- **Kunststoffummantelte Steckverbinder**
- **Tieftemperatur Steckverbinder** für extreme Witterungsbedingungen bis Einsatztemperatur -50°C
- **Sonderpolbilder**
- **Sondercodierungen** für Gehäuse und Isolierkörper
- **Sonderbeschriftungen** auf Isolierkörper und Gehäusen
- **Weitere Oberflächenbeschichtungen** elektrisch leitend und nicht leitend
- **Sonder- und Mehrlochklemmungen**
- **Private Labelling** auf Metallgehäusen und Kunststoffhüllen mit Ihrem Logo. In verschiedenen Farben erhältlich
- **Winkleinbaudosen drehbar** ohne Verdrehanschlag in verschiedenen Flanschmaßen
- **ungesteckt IP 66/67**
- **IP 68**
- **IP 69K**
- **Anschraublöcher Ø 3,2 mm in Flansch 25 x 25**
- **Isolierkörper für D-Sub Kontakte**

Teile-Nr. Kontakt	Einlötzzone		Überstand L1 / L3											
	L2	D1	Einbaudose speedtec		Einbaudose schraub		Einbaudose speedtec, Hinterwandmont.		Einbaudose schraub, Hinterwandmont.		Durchführung speedtec		Durchführung schraub	
Einlötzstifte Ø 1 mm für Signalisierkörper														
			L1	L3	L1	L3	L1	L3	L1	L3	L1	L3	L1	L3
61.043.11	1,5	1	3,5	2,0	5,5	4,0	0	0	0	0	0	0	2,3	0,8
61.014.11	7,5	1	3,9	0	5,9	0	0	0	0	0	0	0	2,7	0
61.036.11	2,4	1	7,5	5,1	9,5	7,1	0	0	0	0	0	0	6,3	3,9
61.042.11	2	1	9,6	7,6	11,6	9,6	2,0	0	0,6	0	2,0	0	8,4	6,4
61.168.11	2,5	1	9,6	7,1	11,6	9,1	2,0	0	0,6	0	2,0	0	8,4	5,9
61.041.11	4	1	10,3	6,3	12,3	8,3	2,7	0	1,4	0	2,7	0	9,1	5,1
61.158.11	4	1	12,6	8,6	14,6	10,6	5,0	1,0	3,7	0	5,0	1,0	11,4	7,4
61.067.11	2,4	1	14,9	12,5	16,9	14,5	7,3	4,9	6,0	3,6	7,3	4,9	13,7	11,3
61.236.11	23,97	1,2	20,0	0	22,0	0	12,4	0	11,1	0	12,4	0	18,8	0
Einlötzstifte Ø 1,5 mm für Signalisierkörper 16+3 Achtung: die Voreilung von Pin 12 (0,5 mm) ist in dieser Berechnung nicht berücksichtigt														
			L1	L3	L1	L3	L1	L3	L1	L3	L1	L3	L1	L3
61.044.11	6,95	1	4,8	0	6,8	0	0	0	0	0	0	0	3,6	0
61.169.11	2,5	1	9,7	7,2	11,7	9,2	2,1	0	0,8	0	2,1	0	8,5	6,0

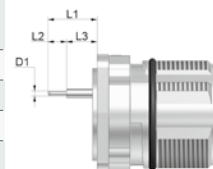

Teile-Nr. Kontakt	Einlötzzone		Überstand L1 / L3											
	L2	D1	Einbaudose speedtec		Einbaudose schraub		Einbaudose speedtec, Hinterwandmont.		Einbaudose schraub, Hinterwandmont.		Durchführung speedtec		Durchführung schraub	
Einlötbuchsen Ø 1 mm für Signalisierkörper														
			L1	L3	L1	L3	L1	L3	L1	L3	L1	L3	L1	L3
60.028.11	3	1	5,0	2,0	7,0	4,0	0	0	0	0	0	0	3,8	0,8
60.066.11	2,4	1	7,5	5,1	9,5	7,1	0	0	0	0	0	0	6,3	3,9
60.044.11	2,4	1	8,0	5,6	10,0	7,6	0,4	0	0	0	0,4	0	6,8	4,4
60.067.11	4	1	10,4	6,4	12,4	8,4	2,8	0	1,5	0	2,8	0	9,2	5,2
60.068.11	4	1	10,8	6,8	12,8	8,8	3,2	0	1,9	0	3,2	0	9,6	5,6
60.211.11	3,9	1	13,7	9,8	15,7	11,8	6,1	2,2	4,8	0,9	6,1	2,2	12,5	8,6
60.212.11	3,9	1	34,2	30,3	36,2	32,3	26,6	22,7	25,3	21,4	26,6	22,7	33,0	29,1
60.258.11	23,93	1,2	20,0	0	22,0	0	12,4	0	11,1	0	12,4	0	18,8	0
Einlötbuchsen Ø 2 mm für Signalisierkörper 6; 7; 8 + 1														
			L1	L3	L1	L3	L1	L3	L1	L3	L1	L3	L1	L3
60.183.11	2,4	1	7,6	5,2	9,6	7,2	0,0	0	0	0	0,0	0	6,4	4,0
60.206.11	4	1	10,6	6,6	12,6	8,6	3,0	0	1,7	0	3,0	0	9,4	5,4

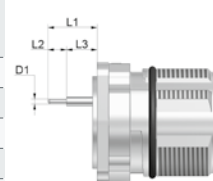

Please contact us for information about available customized solutions and many other possible variations such as

- **Stainless Steel Connectors** for the chemical and food industry as well as shipbuilding
- **Plastic Coated Connectors**
- **Low Temperature Connectors** for extreme weather conditions down to -50°C
- **Special Pin Layouts**
- **Special Codings** for connector housing and insulator
- **Special Labelling** on insulator and connector housing
- **Additional surface coatings available**, conductive or non-conductive
- **Special and Multi-Slot Clamps**
- **Private Labelling** on metal housing and plastic hull with your corporate logo. Available in various colours.
- **Rotatable Angled Receptacles** without anti-twist stop, various flange sizes available
- **Disconnected IP 66/67-protection**
- **IP 68**
- **IP 69K**
- **Screw Holes Ø 3,2 mm in flange 25 x 25**
- **Insulator for D-Sub Contacts**

Part No. Contact	Solder Area		Projection L1 / L3											
	L2	D1	Receptacle speedtec		Receptacle Screw		Receptacle speedtec, rear mount		Receptacle Screw, rear mount		Bulkhead Connector speedtec		Bulkhead Connector Screw	
Solder pins Ø 1 mm for signal insulators														
			L1	L3	L1	L3	L1	L3	L1	L3	L1	L3	L1	L3
61.043.11	1.5	1	3.5	2.0	5.5	4.0	0	0	0	0	0	0	2.3	0.8
61.014.11	7.5	1	3.9	0	5.9	0	0	0	0	0	0	0	2.7	0
61.036.11	2.4	1	7.5	5.1	9.5	7.1	0	0	0	0	0	0	6.3	3.9
61.042.11	2	1	9.6	7.6	11.6	9.6	2.0	0	0.6	0	2.0	0	8.4	6.4
61.168.11	2.5	1	9.6	7.1	11.6	9.1	2.0	0	0.6	0	2.0	0	8.4	5.9
61.041.11	4	1	10.3	6.3	12.3	8.3	2.7	0	1.4	0	2.7	0	9.1	5.1
61.158.11	4	1	12.6	8.6	14.6	10.6	5.0	1.0	3.7	0	5.0	1.0	11.4	7.4
61.067.11	2.4	1	14.9	12.5	16.9	14.5	7.3	4.9	6.0	3.6	7.3	4.9	13.7	11.3
61.236.11	23.97	1.2	20.0	0	22.0	0	12.4	0	11.1	0	12.4	0	18.8	0
Solder pins Ø 1.5 mm for signal insulators 16+3 Please note: The lead of pin 12 (0.5 mm) is not included in this calculation														
			L1	L3	L1	L3	L1	L3	L1	L3	L1	L3	L1	L3
61.044.11	6.95	1	4.8	0	6.8	0	0	0	0	0	0	0	3.6	0
61.169.11	2.5	1	9.7	7.2	11.7	9.2	2.1	0	0.8	0	2.1	0	8.5	6.0

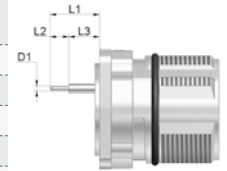

Part No. Contact	Solder Area		Projection L1 / L3											
	L2	D1	Receptacle speedtec		Receptacle screw		Receptacle speedtec, rear mount		Receptacle screw, rear mount		Bulkhead Connector speedtec		Bulkhead Connector screw	
Solder sockets Ø 1 mm for signal insulators														
			L1	L3	L1	L3	L1	L3	L1	L3	L1	L3	L1	L3
60.028.11	3	1	5.0	2.0	7.0	4.0	0	0	0	0	0	0	3.8	0.8
60.066.11	2.4	1	7.5	5.1	9.5	7.1	0	0	0	0	0	0	6.3	3.9
60.044.11	2.4	1	8.0	5.6	10.0	7.6	0.4	0	0	0	0.4	0	6.8	4.4
60.067.11	4	1	10.4	6.4	12.4	8.4	2.8	0	1.5	0	2.8	0	9.2	5.2
60.068.11	4	1	10.8	6.8	12.8	8.8	3.2	0	1.9	0	3.2	0	9.6	5.6
60.211.11	3.9	1	13.7	9.8	15.7	11.8	6.1	2.2	4.8	0.9	6.1	2.2	12.5	8.6
60.212.11	3.9	1	34.2	30.3	36.2	32.3	26.6	22.7	25.3	21.4	26.6	22.7	33.0	29.1
60.258.11	23.93	1.2	20.0	0	22.0	0	12.4	0	11.1	0	12.4	0	18.8	0
Solder sockets Ø 2 mm for signal insulators 6; 7; 8 + 1														
			L1	L3	L1	L3	L1	L3	L1	L3	L1	L3	L1	L3
60.183.11	2.4	1	7.6	5.2	9.6	7.2	0.0	0	0	0	0.0	0	6.4	4.0
60.206.11	4	1	10.6	6.6	12.6	8.6	3.0	0	1.7	0	3.0	0	9.4	5.4

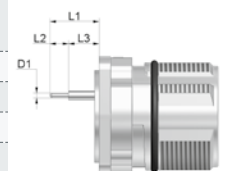

In addition: We realize professionally and flexibly project based, customized as well as exclusive special applications and new developments for all purposes.

Begriffserklärungen Terms and Definitions

Rundsteckverbinder-Technologie

Rundsteckverbinder dienen im industriellen Einsatz zur Übertragung von Signal- und Power-Strömen in den Bereichen der Antriebs- und Steuerungstechnik, Medizintechnik sowie Luft- und Raumfahrt.

Steckverbinder sind Betriebsmittel, die bei bestimmungsgemäßer Verwendung (unter elektrischer Spannung) nicht gesteckt oder getrennt werden dürfen.

Steckvorrichtungen sind Betriebsmittel, die bei bestimmungsgemäßer Verwendung (unter elektrischer Spannung oder Last) gesteckt oder getrennt werden dürfen.

Anschlussstechniken

Crimpen kommt aus dem Englischen und bedeutet so viel wie: pressen, eindrücken und falten. Crimpverbindungen haben in den letzten Jahren Lötverbindungen weitgehend abgelöst und sich über Jahre hinweg bewährt. Beurteilungskriterien werden unter anderem in der Norm DIN EN 60352 vorgegeben. Eine Crimpverbindung ist eine nicht lösbare elektrische Verbindung zwischen einem Leiter und einem Crimpkontakt. Wichtige Kriterien zum Prüfen der Crimpung sind: Crimpbreite, Crimphöhe und Ausziehungskraft. Für Crimpungen stehen zwei unterschiedliche Kontaktarten zur Verfügung:

Circular Connector Technology

Circular Connectors are used to transmit electrical power and signals to motors, drives and controls in industrial, medical and environmental technology applications as well as aerospace.

Connectors must neither be connected nor disconnected under voltage and load.

Couplers can be connected and disconnected under voltage and load.

Connection Technologies

To crimp means to press, to indent and to fold. Crimp connections have widely replaced solder connections and have delivered optimal performance in practice. DIN Standard EN 60352 amongst others provides specifications for the crimp quality. A crimp is a permanent electrical connection of a wire and a crimp contact. Important test criteria are crimp width, crimp height and maximum tensile stress. There are two different contact types available for crimping:

Turned Contacts This is a very common contact type. The wire gage is adapted to the contact's crimp sleeve. When using an adjustable crimp tool the depth of the crimp should be set according to manufacturer's data.

Gedrehte Kontakte Sehr gängige Kontaktart bei dem der Leiterquerschnitt auf eine bestimmte Crimphülse ausgelegt ist. Bei verstellbaren Werkzeugen muss die Einstellung der Crimptiefe separat nach Herstellerangaben erfolgen.

Gestanzte Kontakte Die Bandkontakte sind zur Erreichung einer guten Anpassung des Leiters an den Kontakt in verschiedene Crimpgrößen unterteilt. Durch die maschinelle Verarbeitung wird eine ausgezeichnete Prozesssicherheit erreicht. Der Isolationscrimp sorgt zusätzlich für eine hohe mechanische Belastung der Crimpverbindung.

Begriffe zu Luft- und Kriechstrecken

Bemessungsspannung Wert einer Spannung, der vom Hersteller für einen Steckverbinder angegeben wird und auf den sich die Betriebs- und Leistungsangaben beziehen.

Bemessungs-Stoßspannung Wert einer Stehstoßspannung, der vom Hersteller für einen Steckverbinder angegeben wird und der das festgelegte Stehvermögen seiner Isolierung gegenüber zeitweiliger Überspannung angibt.

Luftstrecke Kürzeste Entfernung in Luft zwischen zwei leitenden Teilen.

Kriechstrecke Kürzeste Entfernung entlang der Oberfläche eines Isolierstoffes zwischen zwei leitenden Teilen.

Stamped Contacts Bandoleer (reel feed) contacts are divided into different crimp sizes to provide a secure connection of wire and contact. Automated processing ensures highest process liability. The insulation crimp gives additional support to the conductor to avoid damage to the wires under vibration

Clearance and Creepage Distance - Terms and Definitions

Rated Voltage The rated voltage is a voltage value specified by the manufacturer that serves as basis for the power rating and range of application of a connector.

Rated Withstanding Voltage This voltage value indicates the maximum temporary overvoltage a specific connector and its insulation materials can carry.

Clearance Distance The clearance distance is defined as shortest distance through the air between two conductive elements.

Creepage Distance The creepage is defined as shortest distance on the surface of an insulating material between two conductive elements.

Überspannungskategorien

Die Norm hat die möglichen Überspannungen in vier Kategorien eingeteilt. Für Steckverbinder finden die Kategorien I bis III Anwendung:

Überspannungskategorie I: Betriebsmittel, wie z. B. Steckverbinder, die zur Anwendung in Geräten oder Teilen von Anlagen bestimmt sind, in denen keine Überspannungen auftreten können.

Überspannungskategorie II: Betriebsmittel, wie z. B. Steckverbinder, die zur Anwendung in Geräten oder Teilen von Anlagen bestimmt sind, in denen Blitzüberspannungen nicht berücksichtigt werden müssen, aber wohl Überspannungen durch Schaltvorgänge.

Überspannungskategorie III: Betriebsmittel, wie z. B. Steckverbinder, die zur Anwendung in Geräten oder Teilen von Anlagen bestimmt sind, in denen Blitzüberspannungen nicht berücksichtigt werden müssen, wohl aber Überspannungen durch Schaltvorgänge und an die im Hinblick auf die Sicherheit und Verfügbarkeit des Betriebsmittels oder von davon abhängigen Netzen besondere Anforderungen gestellt werden.

Isolierstoffgruppen Bei der Bemessung der Kriechstrecke muss die Kriechwegbildung des vom Hersteller verwendeten Isolierstoffes berücksichtigt werden. Die Isolierstoffe werden entsprechend ihrem Kriechwegbildungsfaktor CTI eingeteilt.

Overvoltage Categories

The norm divides overvoltages in four installation categories. The three categories applicable to connectors are briefly described below:

Installation Category I: Equipment is intended for use only in such machines or as part of systems where no overvoltage can occur. Equipment in this installation category is normally operated at extra low voltage.

Installation Category II: Equipment is intended for use in machines or as part of systems where lightning overvoltages can not occur. Overvoltages caused by switching however may occur. This includes domestic appliances for example.

Installation Category III: Equipment is intended for installation in machines or as part of systems in which lightning overvoltages need not be considered, but which are subject to particular requirements regarding safety and availability of the equipment and its supply systems.

Categorization of Insulation Material The creepage distances depend on the tracking characteristics of the insulation material. Insulation materials are categorized according to their Comparative Tracking Index (CTI).

Bestellschlüssel
Product Key

A S T A 0 1 4 N N 0 0 4 1 0 2 3 5 0 0 0

Baureihe:

z.B.: A = Serie 623: Signal M23

Series:

e. g.: A = series 623: signal M23

Bauform:

ST = Stecker

Housing:

ST = plug

Gehäuseoberfläche:

z.B.: A = vernickelt

Housing Surface:

e. g.: A = nickel-plated

Isolierkörper:

Interner Nummerncode

Insulation Inserts:

internal code

Verpackung:

Interner Nummerncode

Packaging:

internal code

Ausführung:

Interner Nummerncode

Design Variation:

internal code

Kabelklemmung:

Interner Nummerncode

Das entsprechende Feld wird bei Durchführungen, Einbaudosen und Winkeleinbaudosen mit „00“ belegt.

Cable Clamp:

internal code

For bulkhead connectors, receptacles and angled receptacles corresponding field is marked „00“.

Kontakte:

Interner Nummerncode

NN 00 = Kontakte nicht im Lieferumfang enthalten. Bitte mit angegebener Artikelnummer separat bestellen.

Contacts:

internal code

NN 00 = contacts not part of delivery contents. Please order separately with denoted item number.

Umrechnungstabelle gängiger Kupferleitungen in AWG und mm²
Conversion table of prevalent copper wires in AWG and mm²

IP-Schutzart nach DIN 40050
IP protection rating according to DIN 40050

Leiterquerschnitt Wire Cross-Section		Leiterdurchmesser Wire Diameter		
AWG	mm ²	sq. inches	mm	inches
40	0,005	0,000008	0,080	0,00315
39	0,006	0,000010	0,090	0,00353
38	0,008	0,000012	0,101	0,00397
37	0,010	0,000016	0,113	0,00445
36	0,013	0,000020	0,127	0,00500
35	0,016	0,000025	0,134	0,00562
34	0,020	0,000031	0,160	0,00631
33	0,025	0,000039	0,180	0,00708
32	0,032	0,000050	0,202	0,00795
31	0,040	0,000063	0,227	0,00893
30	0,051	0,000079	0,255	0,01003
29	0,064	0,000100	0,286	0,01126
28	0,081	0,000125	0,321	0,01264
27	0,102	0,000158	0,361	0,01420
26	0,129	0,000200	0,405	0,01594
25	0,162	0,000252	0,455	0,01790
24	0,205	0,000317	0,511	0,02010
23	0,258	0,000400	0,573	0,02257
22	0,326	0,000505	0,644	0,02535
21	0,410	0,000636	0,723	0,02846
20	0,518	0,000802	0,812	0,03196
19	0,653	0,001012	0,912	0,03589
18	0,823	0,001276	1,024	0,04030
17	1,038	0,001609	1,150	0,04526
16	1,309	0,002028	1,291	0,05082
15	1,650	0,002558	1,450	0,05707
14	2,081	0,003225	1,628	0,06408
13	2,624	0,004067	1,828	0,07196
12	3,309	0,005129	2,053	0,08081
11	4,172	0,006467	2,305	0,09074
10	5,261	0,008155	2,588	0,10190
9	6,631	0,010279	2,906	0,11440
8	8,367	0,012969	3,264	0,12850
7	10,551	0,016354	3,665	0,14430
6	13,298	0,020612	4,115	0,16200
5	16,766	0,025987	4,620	0,18190
4	21,149	0,032781	5,189	0,20430
3	26,665	0,041331	5,827	0,22940
2	33,624	0,052117	6,543	0,25760
1	42,409	0,065733	7,348	0,28930
0	53,488	0,082907	8,252	0,32490

1. Kennziffer 1 st Digit		
Kennz. No.	Definition Definition	Bemerkung Comment
0	Nicht geschützt No protection	
1	Geschützt gegen den Zugang zu gefährlichen Teilen mit dem Handrücken. Geschützt gegen feste Fremdkörper Ø 50 mm. Protected against solid foreign objects with a diameter of 50 mm or larger.	
2	Geschützt gegen den Zugang zu gefährlichen Teilen mit einem Finger. Geschützt gegen feste Fremdkörper Ø 12,5 mm. Protected against solid foreign objects with a diameter of 12.5 mm or larger.	
3	Geschützt gegen den Zugang zu gefährlichen Teilen mit einem Werkzeug. Geschützt gegen feste Fremdkörper Ø 2,5 mm. Protected against solid foreign objects with a diameter of 2.5 mm or larger.	
4	Geschützt gegen den Zugang zu gefährlichen Teilen mit einem Draht. Geschützt gegen feste Fremdkörper Ø 1 mm. Protected against solid foreign objects with a diameter of 1 mm or larger.	
5	Geschützt gegen den Zugang zu gefährlichen Teilen mit einem Draht. Staubgeschützt. Dust-protected.	Eindringen von Staub ist nicht vollständig verhindert, aber der Staub darf nicht in einer solchen Menge eindringen, dass das zufriedenstellende Arbeiten des Gerätes oder die Sicherheit beeinträchtigt wird. Ingress of dust is not totally prevented, but dust shall not penetrate in a quantity to interfere with satisfactory operation of the apparatus or to impair safety.
6	Geschützt gegen den Zugang zu gefährlichen Teilen mit einem Draht. Staubsicht. Dust tight.	Kein Eindringen von Staub. No ingress of dust.

IP-Schutzart nach DIN 40050
IP protection rating according to DIN 40050

2. Kennziffer 2 nd Digit		
Kennz. No.	Definition	Bemerkung Comment
0	Nicht geschützt No protection	
1	Geschützt gegen Tropfwasser Protected against vertically falling water drops	
2	Geschützt gegen Tropfwasser, wenn das Gehäuse bis zu 15° geneigt ist Protected against vertically falling water drops when housing ist tilted up to 15°	
3	Geschützt gegen Sprühwasser Protected against water sprays	Wasser, das in einem Winkel bis zu 60° beiderseits der Senkrechten gesprüht wird, darf keine schädliche Wirkung haben. Water sprayed at a 60° angle from either side of the vertical axis, shall have no harmful effect.
4	Geschützt gegen Spritzwasser Protected against splashed water	Wasser, das aus jeder Richtung gegen das Gehäuse spritzt, darf keine schädliche Wirkungen haben. Water splashed against the housing from any direction shall have no harmful effect.
5	Geschützt gegen Strahlwasser Protected against jets of water	
6	Geschützt gegen starkes Strahlwasser Protected against powerful jets of water	
6K	Schutz gegen Eindringen von starkem Strahlwasser mit erhöhtem Druck Protected against strong jets of water with increased pressure	Wasser, das aus jeder Richtung als starker Strahl mit erhöhtem Druck gegen das Gehäuse gerichtet ist, darf keine schädlichen Wirkungen haben. Water directed at the housing in form of a strong jet with increased pressure shall have no harmful effect.
7	Geschützt gegen Wirkungen beim zeitweiligen Untertauchen in Wasser Protected against the effects of temporary immersion in water	Wasser darf nicht in einer Menge eintreten, die schädliche Wirkungen verursacht, wenn das Gehäuse für 30 Min. in 1 m Tiefe in Wasser untergetaucht ist. Water shall not enter in such quantity as to cause harmful effects when the housing is immersed for 30 min. under 1 m of water.
8	Geschützt gegen die Wirkungen beim dauernden Untertauchen in Wasser Protected against the effects of long submersion in water	Wasser darf nicht in einer Menge eintreten, die schädliche Wirkungen verursacht, wenn das Gehäuse dauernd unter Wasser getaucht ist unter Bedingungen, die zwischen Hersteller und Anwender vereinbart werden müssen. Die Bedingungen müssen jedoch schwieriger sein als für die Kennziffer 7. Water may not enter in such quantity as to cause harmful effects when the housing is continuously submersed in water under conditions which shall be agreed to by manufacturer and user. These conditions must be more severe than those above for numeral 7.
9K	Schutz gegen Eindringen von Wasser bei Hochdruck- / Dampfstrahl-Reinigung Protected against the penetration of water during high pressure / steam cleaning	Wasser, das aus jeder Richtung unter stark erhöhtem Druck gegen das Gehäuse gerichtet ist, darf keine schädlichen Wirkungen haben. Water directed at the housing from any direction and with increased pressure shall not have any harmful effect.

1. Alle in diesem Katalog enthaltenen Angaben und Abbildungen sind unverbindlich, besonders in Bezug auf Ausführung, Größe und Farbe der Produkte. Intercontec behält sich Änderungen an Design und technischer Ausstattung der Produkte vor.

1. All information and figures in the catalogue are non-obligatory regarding design, size and color of products in particular. Intercontec reserves the right to change the design and technical features of the products.

2. Die Eigentums- und Urheberrechte an allen Abbildungen, Zeichnungen und sonstigen Unterlagen stehen ausschließlich Intercontec zu. Dies gilt insbesondere für als *vertraulich* gekennzeichnete Unterlagen. Eine Weitergabe an Dritte bedarf der ausdrücklichen schriftlichen Zustimmung seitens Intercontec.

2. Copyright and right of ownership in and to all figures, drawings and other documents shall remain with Intercontec. This is particularly applicable to documents marked as *confidential*. Sharing of data with third parties requires prior consent in writing from Intercontec.

3. Soweit dies im Einzelfall angemessen und zumutbar ist, behält sich Intercontec das Recht vor, auch nach Eingang einer Bestellung und/oder Auftragsannahme Änderungen vorzunehmen, die der technischen Optimierung von Produkten dienen.

3. In individual cases Intercontec reserves the right to any changes contributing to the technical improvement of the products as appropriate and reasonable also after receipt and acceptance of orders.

Notizen
Notes

A large grid of graph paper for taking notes, consisting of 20 columns and 30 rows of small squares.

Notizen
Notes



intercontec

infinite connections



Intercontec Produkt GmbH

Bernrieder Strasse 15
94559 Niederwinkling
Germany

+49 9962 2002-0
+49 9962 2002-70

✉ info@intercontec.biz

www.intercontec.biz

Intercontec Limited

233-4 Mapleview Drive East
Barrie, Ontario
L4N 0W5
Kanada

+1-705-728-8284
+1-705-728-7858

✉ info-canada@intercontec.biz